

BLUM FLATPAX OFFICE FURNITURE RANGE

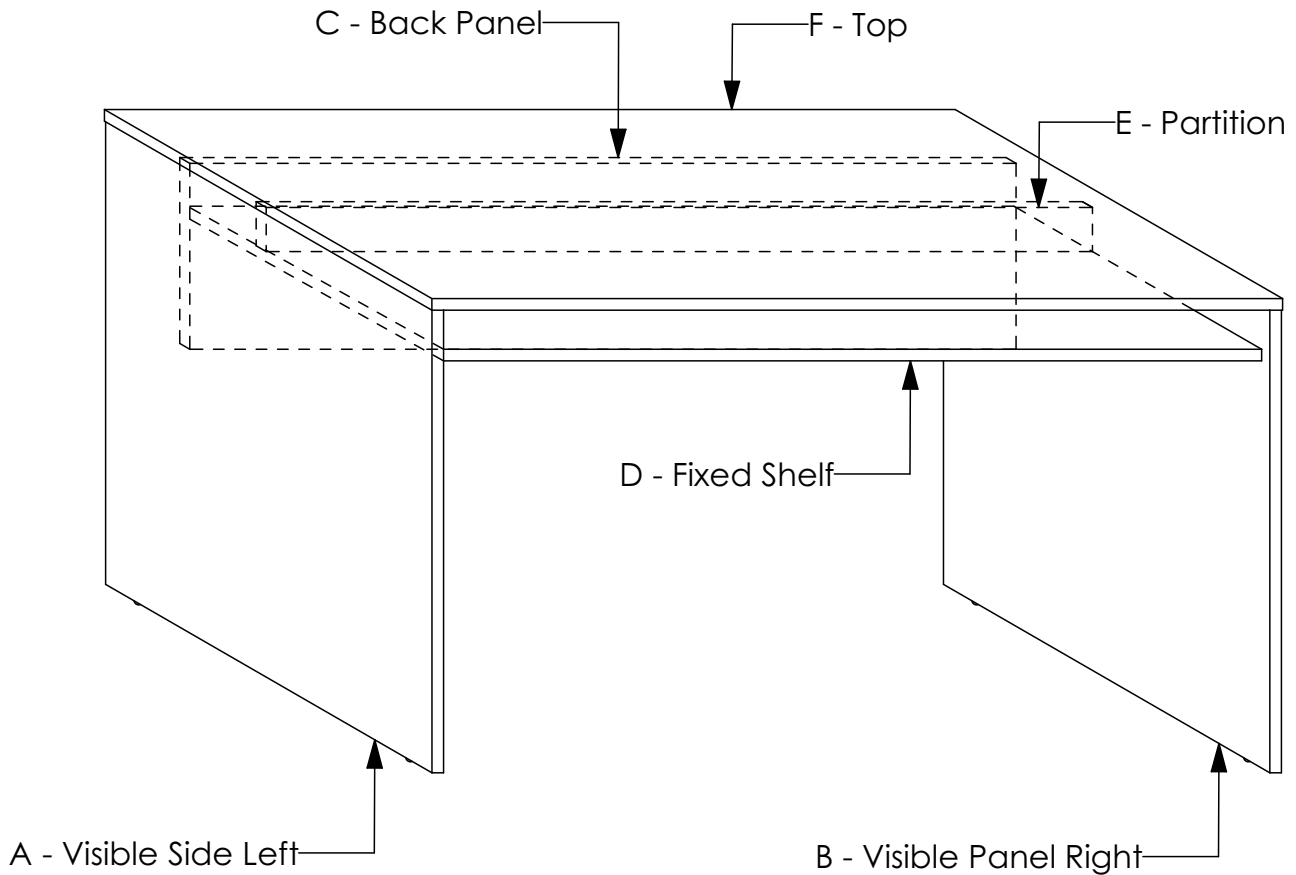



ASSEMBLY GUIDE

DESK 900mm X 600mm X 760mm



TOTAL NUMBER OF PANELS: 6

HARDWARE

PRODUCT	QTY	IMAGE
Dufix	18	
Minifix	18	
Wooden Dowel	36	
Plastic Glide Brown	4	

TOOLS REQUIRED



Screw Driver
(Pozi Drive Head)



Cordless Drill

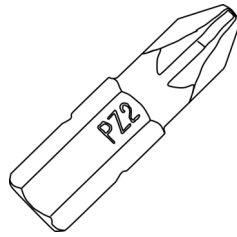

Pozi Bit (PZ2)

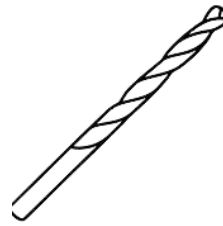

8mm Drill Bit



Rubber Mallet

GENERAL INSTRUCTIONS

1. Confirm that all panels (6) are in the package before assembling.
2. Check the white sticker on each panel for the labelling (A, B, C, D, E & F).
3. Ensure that the panels are laid on a non-abrasive surface when assembling.
4. Note that all panel connections are done using the system described below.

PANEL CONNECTION AND FASTENING

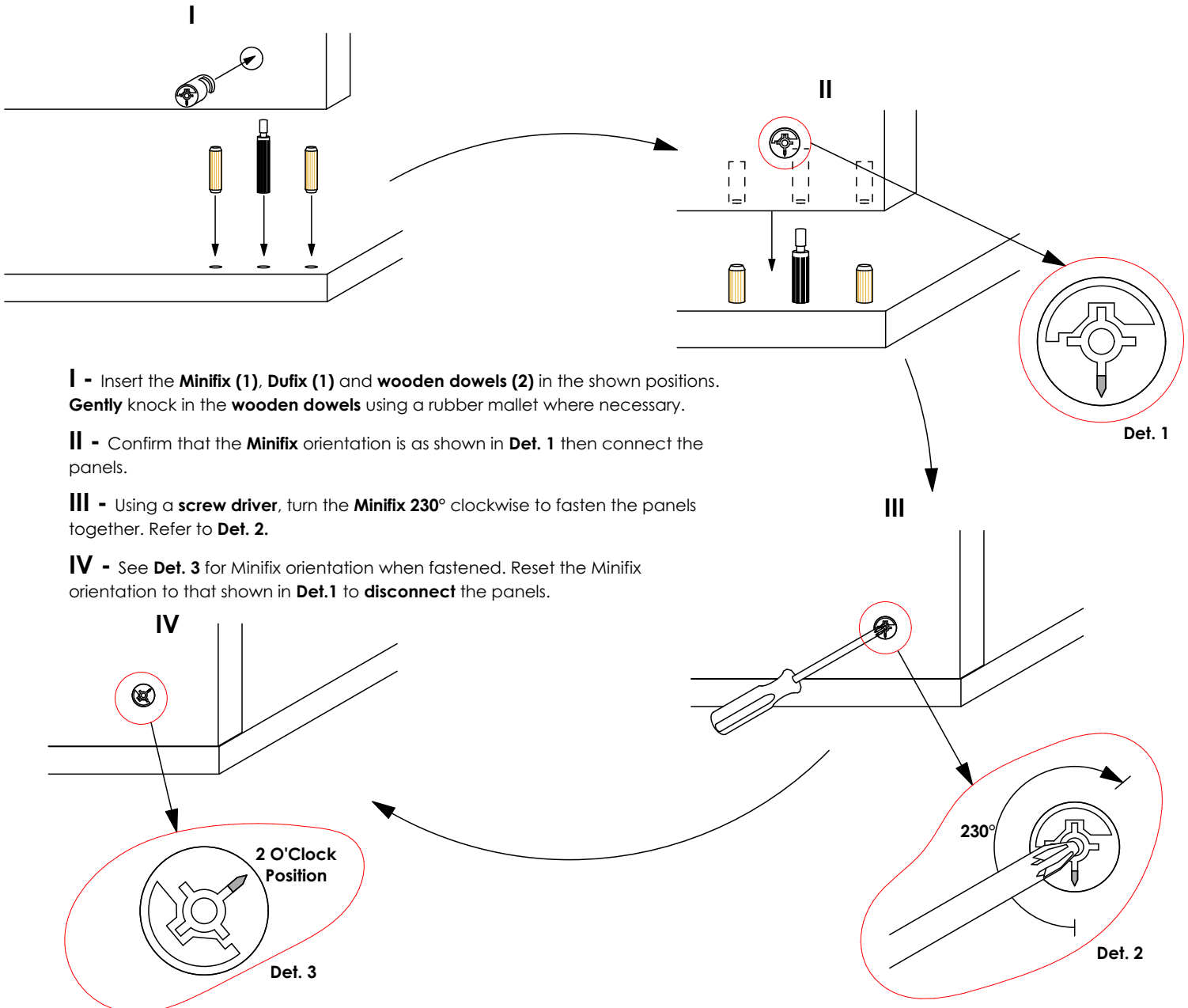

STEP 1

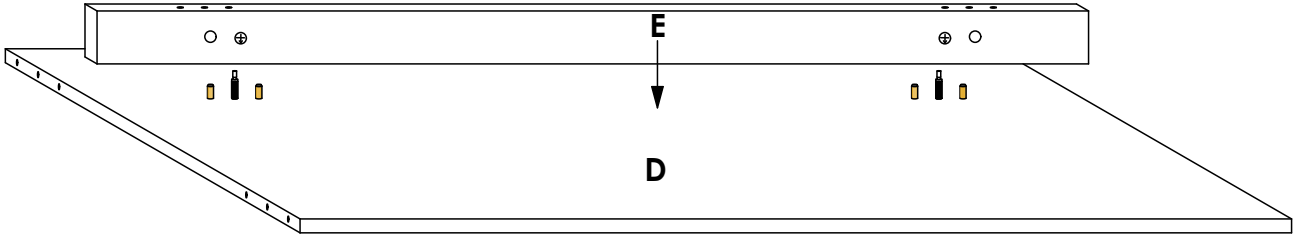

Connect panel **E** to panel **D** as shown. Refer to the holes and/or grooves on the diagram to determine the panel orientation.

STEP 2

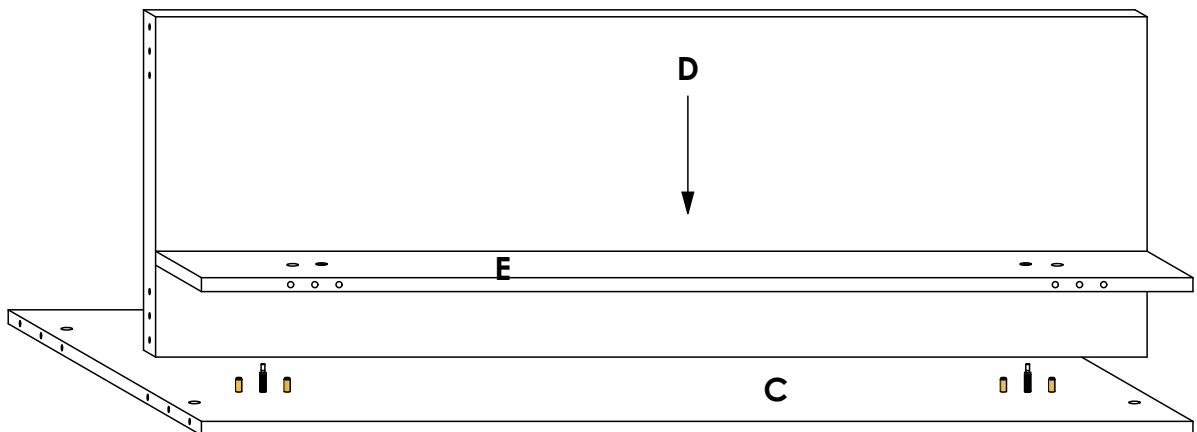

Connect panel **D** to panel **C** as shown. Refer to the holes and/or grooves on the diagram to determine the panel orientation.

STEP 3

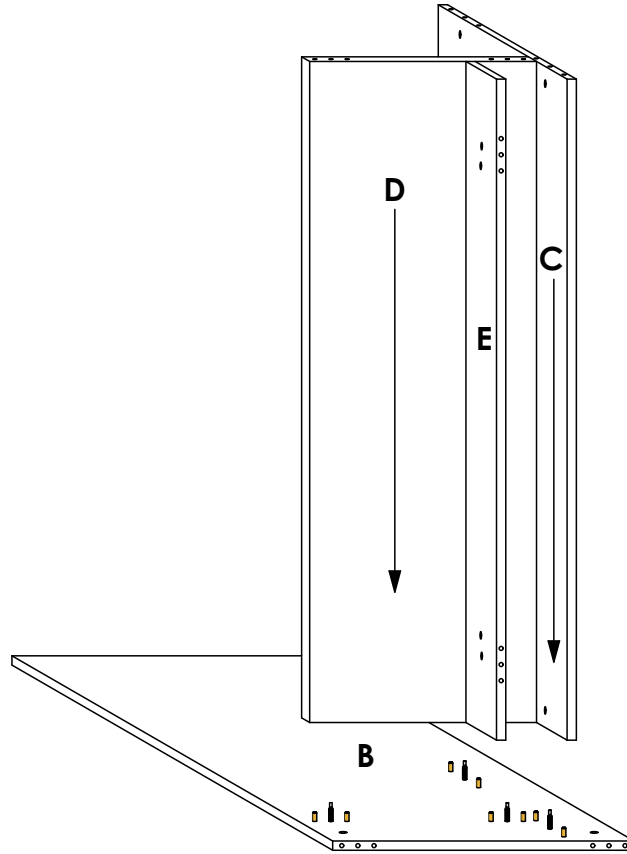

Connect panels **C & D** to panel **B** as shown. Refer to the holes and/or grooves on the diagram to determine the panel orientation.

STEP 4

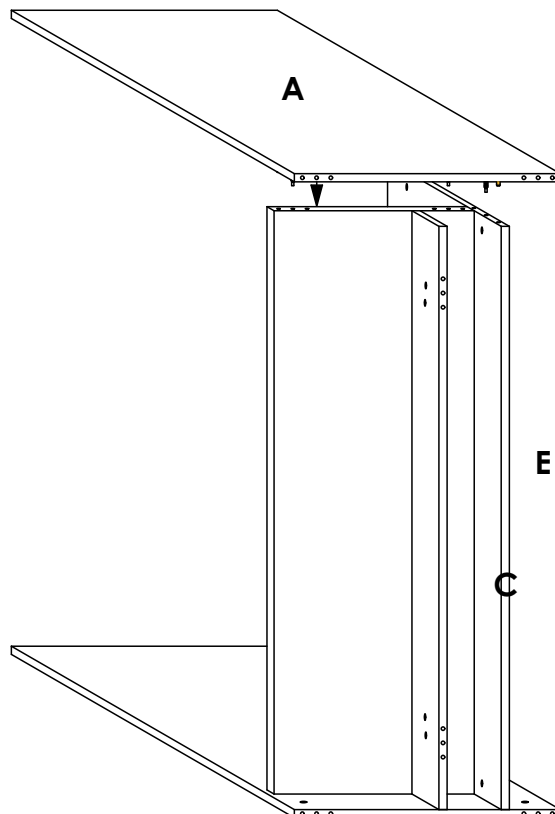

Connect panel **A** to panels **C & D** as shown. Refer to the holes and/or grooves on the diagram to determine the panel orientation.

STEP 5

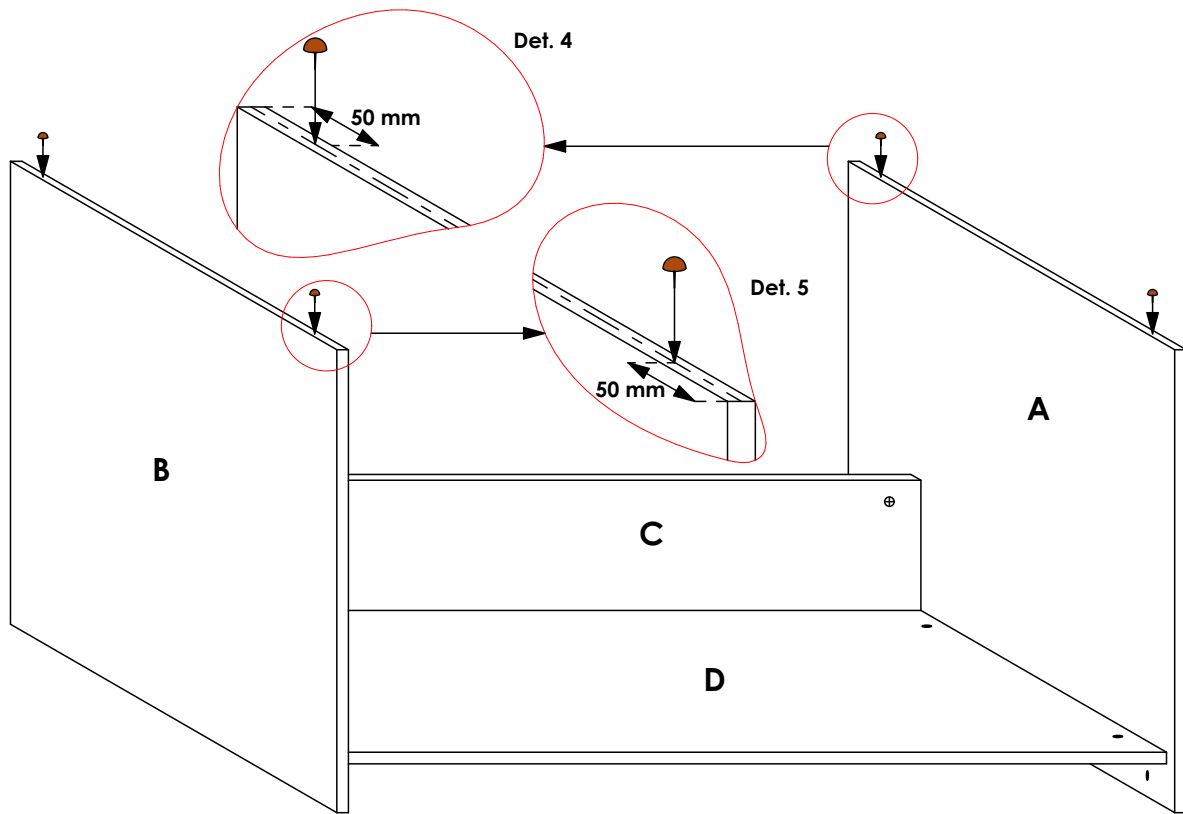

Flip the base up-side-down and using a **rubber mallet**, knock in the **Plastic Glides** in the shown positions on panels **A & B**. Refer to **Det. 4** and **Det. 5**.

STEP 6

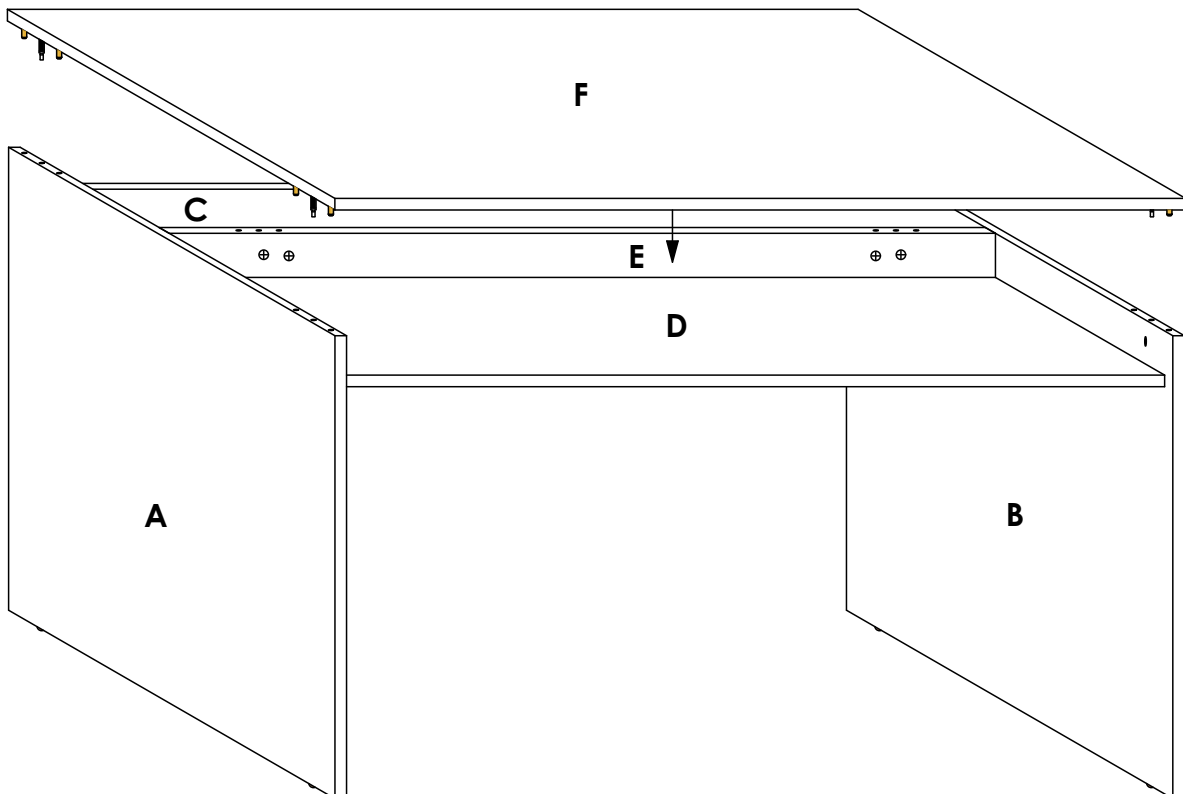

Connect panel **F** to panel **A, B & E** as shown. Refer to the holes on the diagram to determine the panel orientation.