

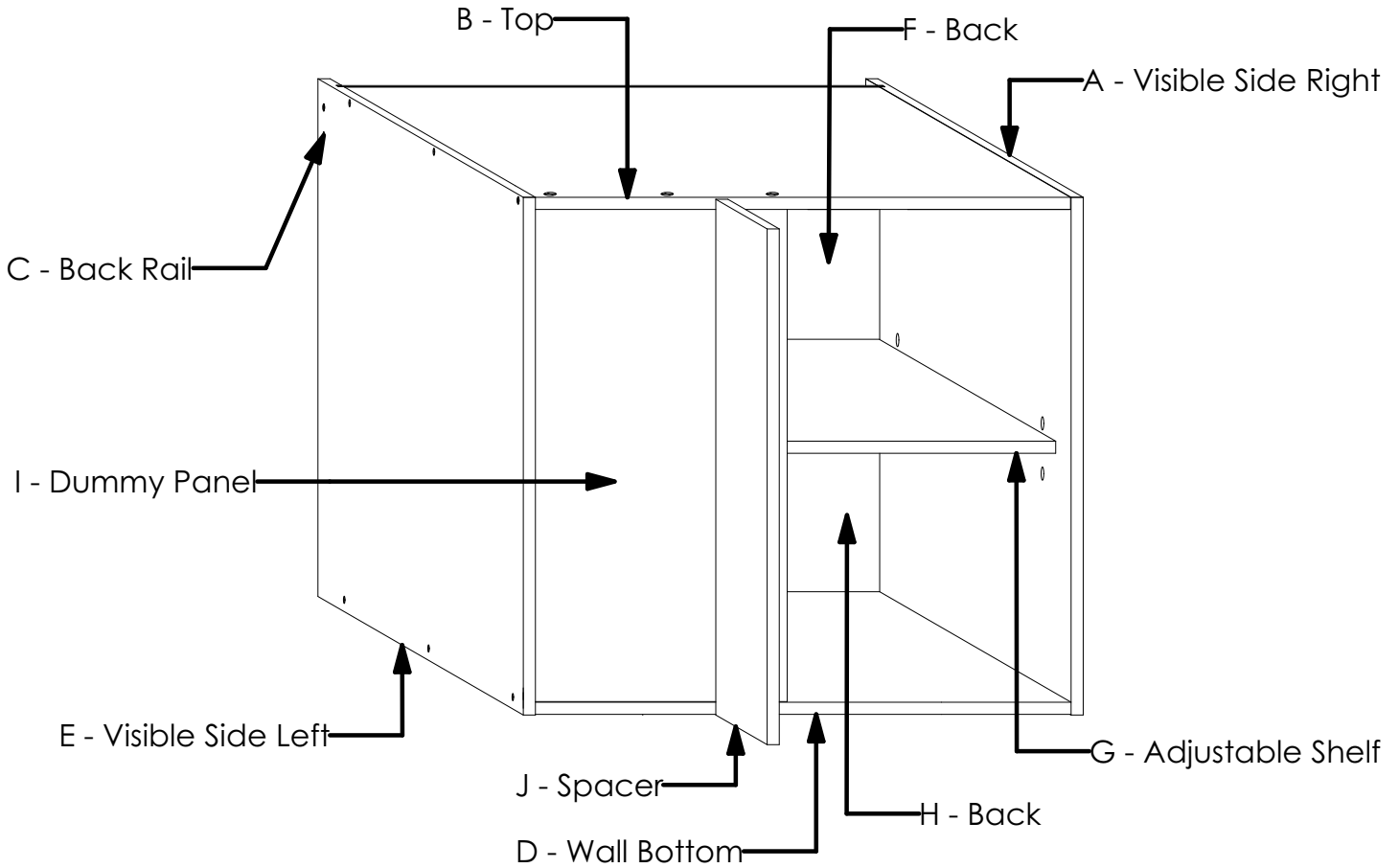





KINETIC FLATPAX RANGE ASSEMBLY GUIDE

WALL CABINET CORNER - RIGHT 850mm



TOTAL NUMBER OF PANELS: 10

HARDWARE

PRODUCT	QTY	IMAGE
Screw 4.0 x 50mm	25	
Shelf Studs	4	
Screw 3.5 x 16mm	10	
Screw Cap Super White	2	
Screw 3.5 x 16mm	2	
H Profile Backer Connector	1	

GENERAL INSTRUCTIONS

1. Confirm that all panels (10) are in the package before assembling.
2. Check the white sticker on each panel for the labelling (A, B, C, D, E, F, G, H, I & J).
3. Ensure that the panels are laid on a non-abrasive surface when assembling.
4. Countersink the holes on the side panels before inserting the screws.
5. Ensure that the screw is perpendicular to the surface being drilled for a clean and strong joint.

TOOLS REQUIRED



Screw Driver
(Pozi Drive Head)



Cordless Drill

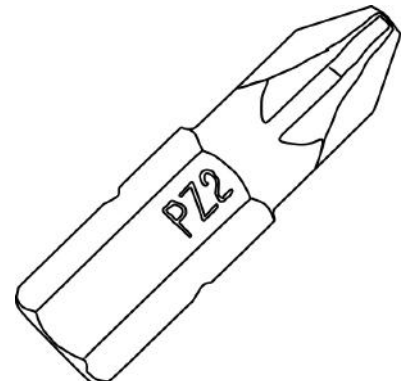

Pozi Bit (PZ2)



8mm Drill Bit



Rubber Mallet

STEP 1

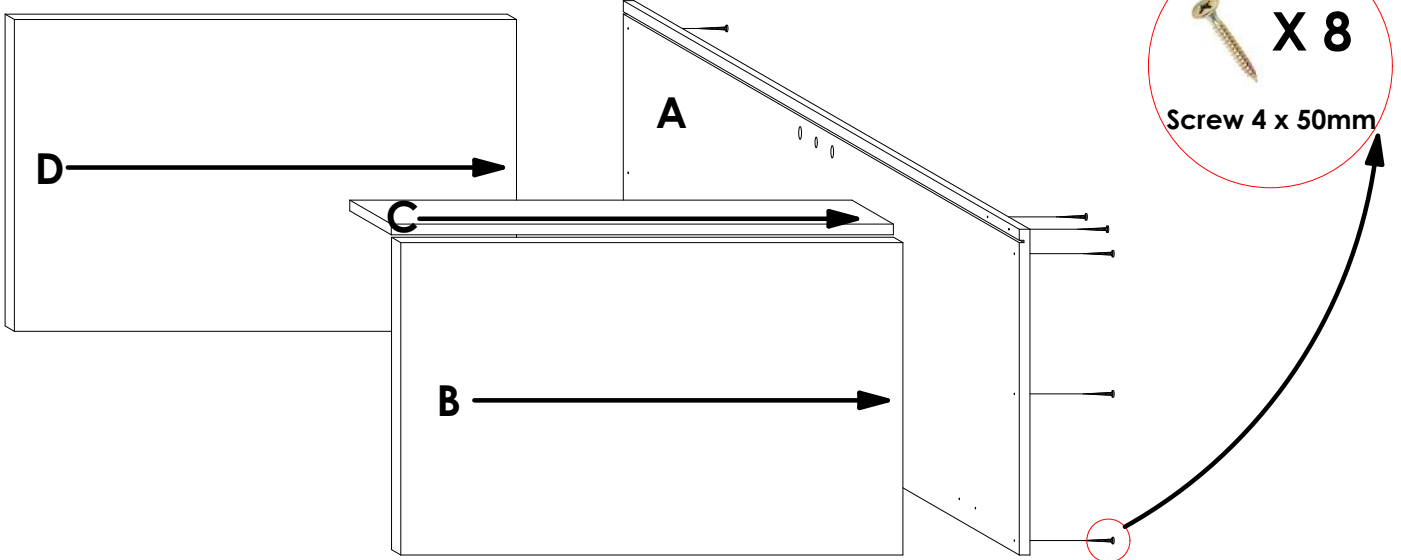

Connect panels **B, C & D** to panel **A** using **Screw 4.0 X 50mm** in the pre-drilled pilot holes as shown. Refer to **Det 1 - 3** below before fastening the screws.

STEP 2

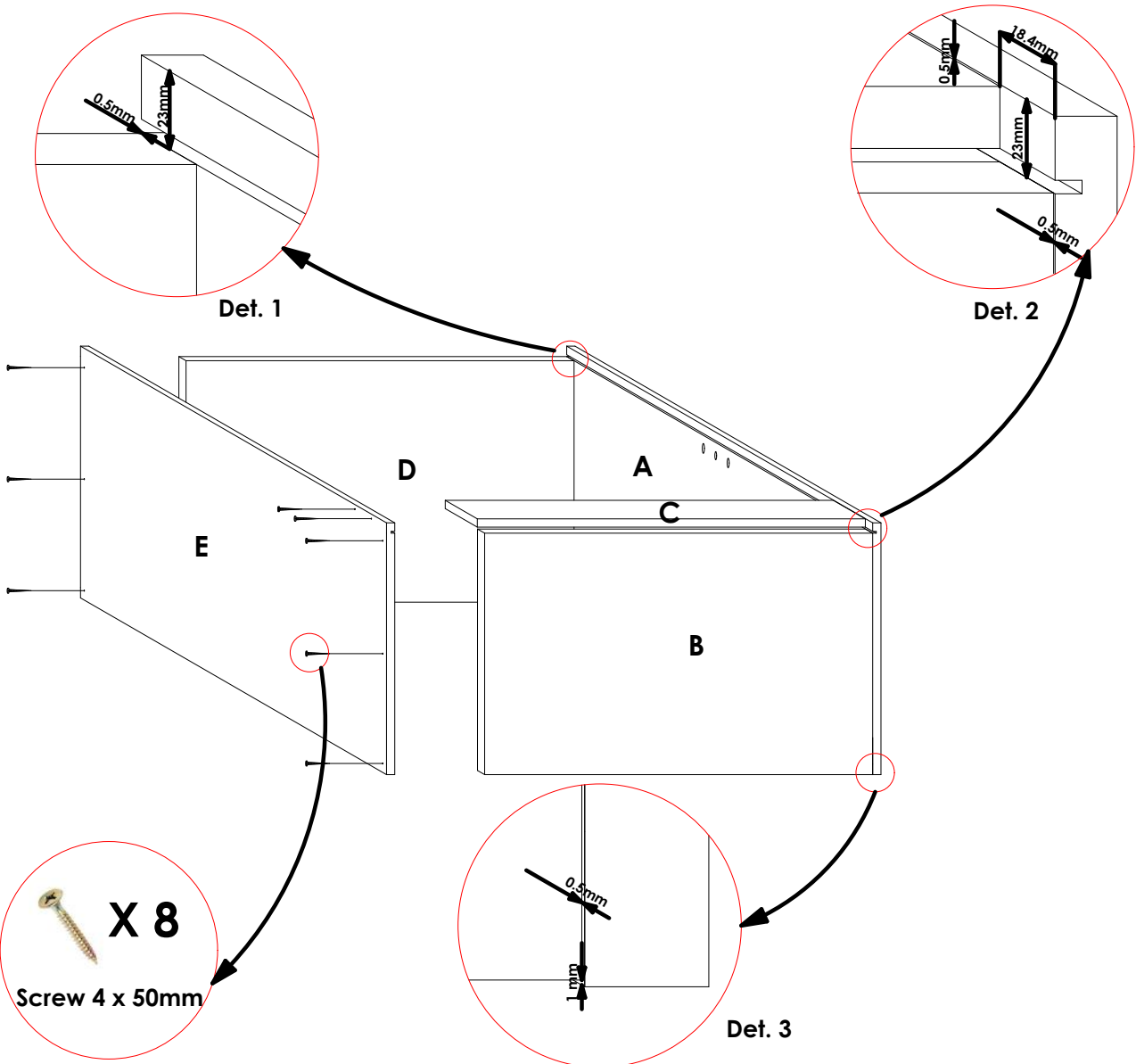

Connect panel **E** to panels **B, C & D** using **Screw 4.0 X 50mm** in the pre-drilled pilot holes as shown. Ensure that the **symmetry** between panel **E** and panel **A** is maintained. Refer to **Det 1 - 3**.

STEP 3

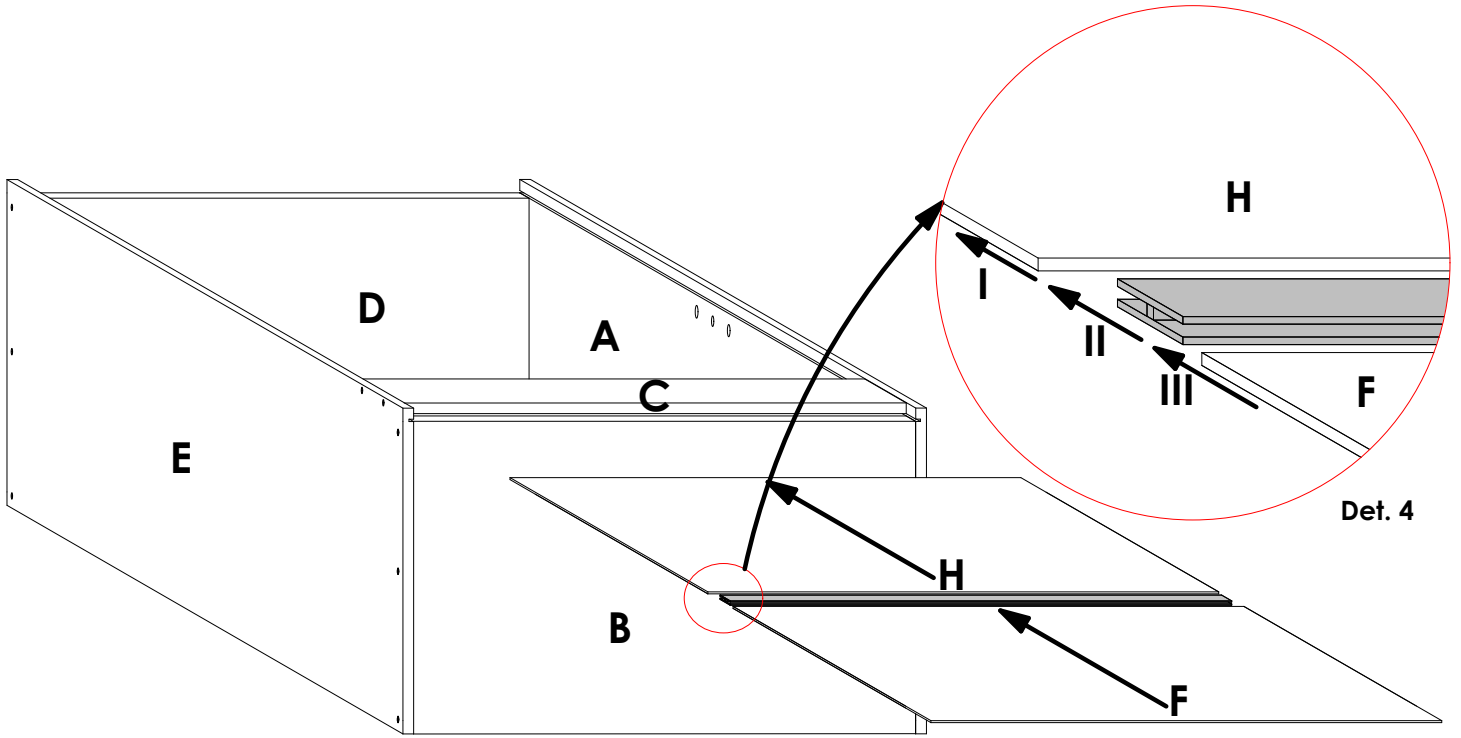

Slide 3mm panel **H** into the groove on panels **A & E** with the finished side facing inside the cabinet. After, insert the **H Profile Backer Connector** into panel **H** as shown (See **Det. 4**). To finish this step, slide 3mm panel **F** into the groove on panels **A & E** and into the **H Profile Backer Connector** as shown in **Det. 1**.

STEP 4

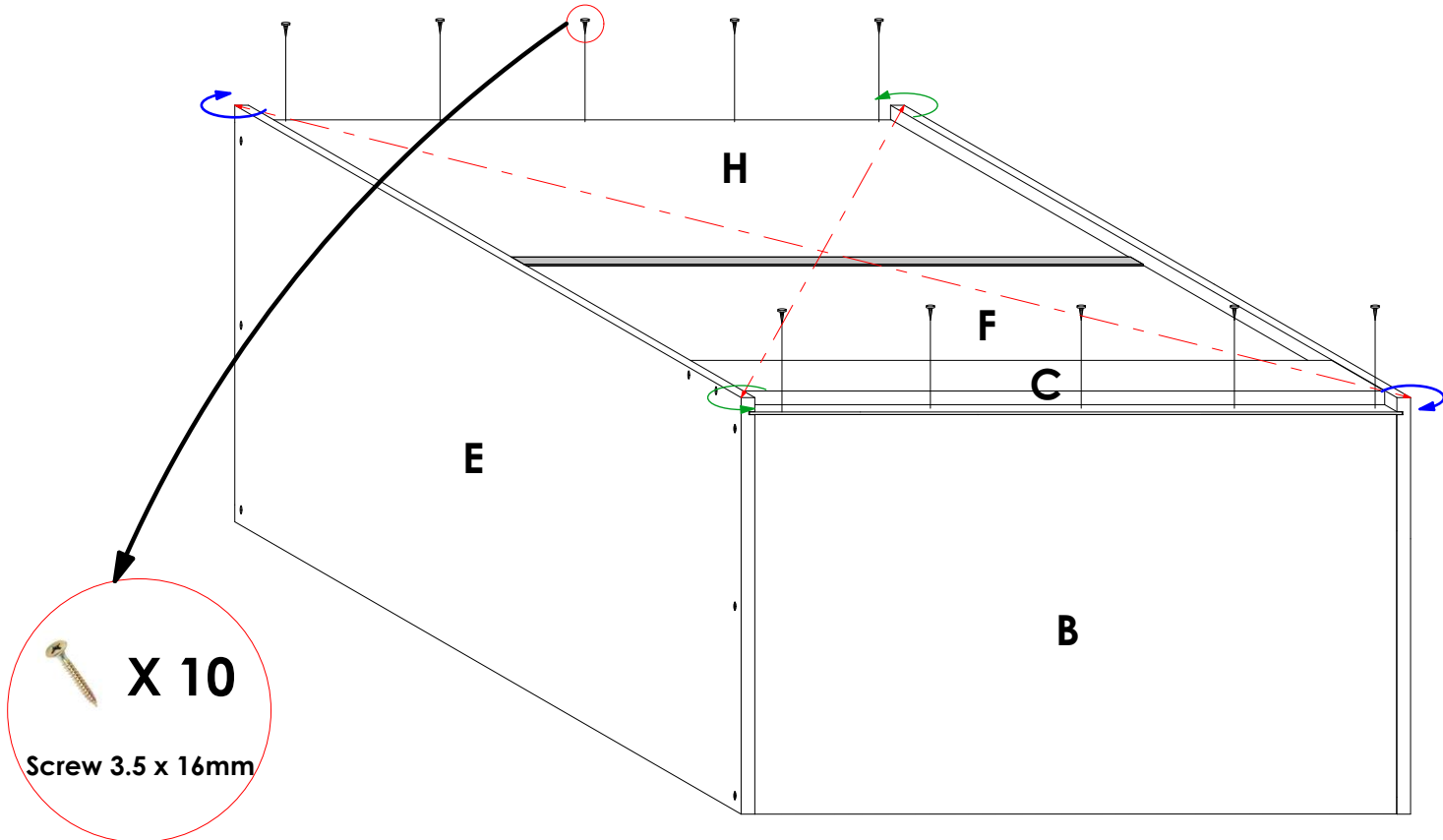

First, **check the diagonal** of the cabinet by measuring the two distances indicated by the red, broken lines. They should be equal. If not, twist the cabinet accordingly in the diagonal corners as shown until an equal value is achieved. After, secure panel **F** to panels **B & D** as shown using **Screw 3.5 X 16mm**.

STEP 5

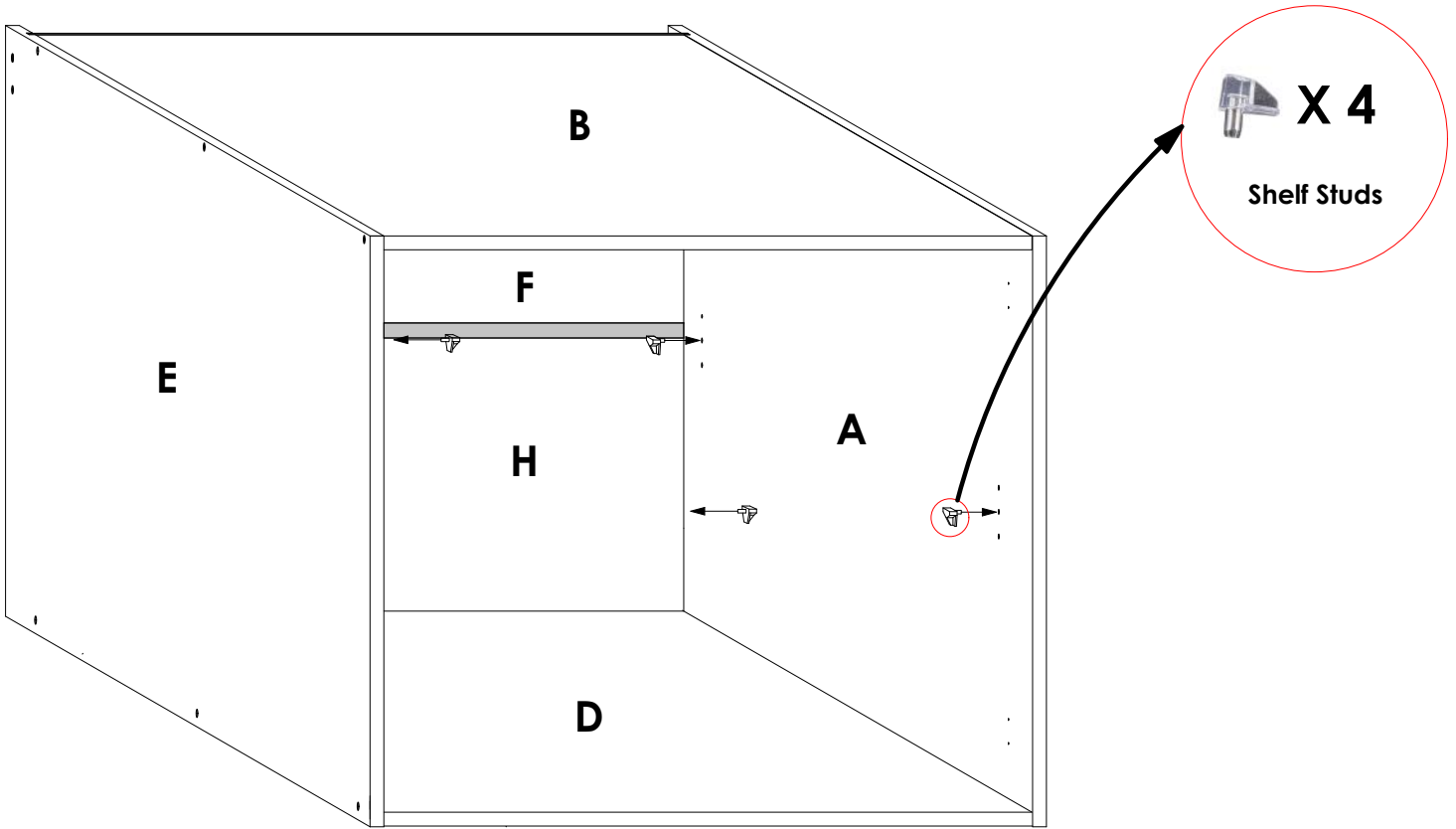

Insert the **Shelf Studs** in the shown positions.

STEP 6

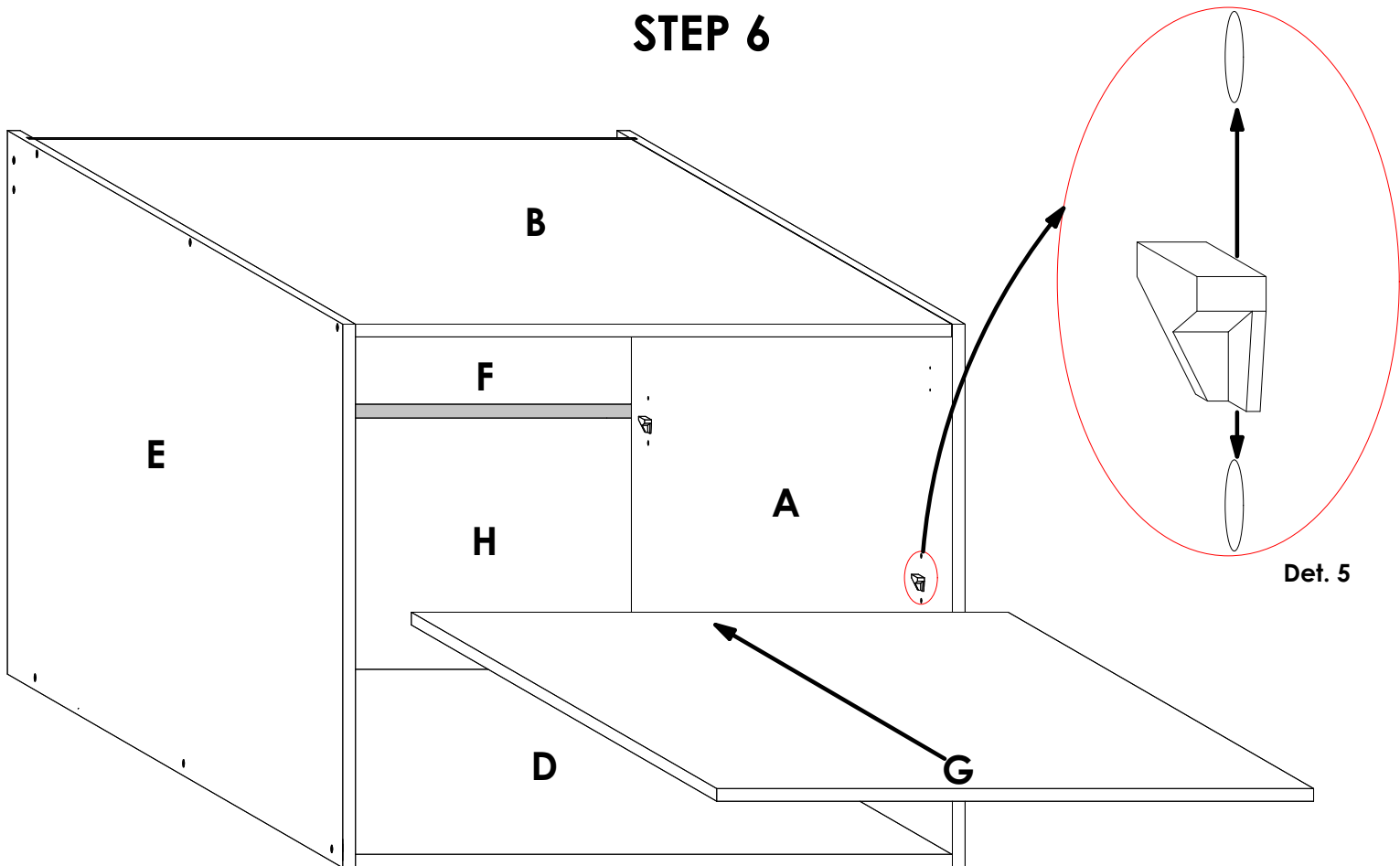

Slide in panel **G** as shown, such that it sits on the four shelf studs. The level of the shelf is adjustable by shifting the position of the shelf studs as shown in **Det. 5**. See Door Installation Guide for further instructions.

STEP 7

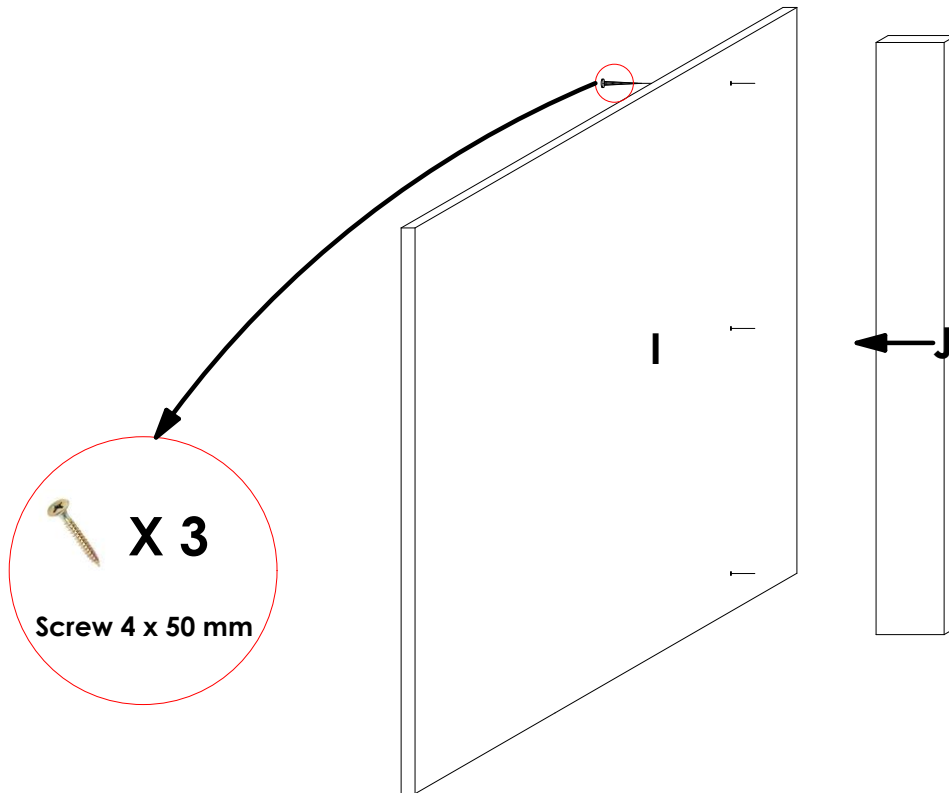

Connect panel **J** to panel **I** using **Screw 4.0 X 50mm** in the pre-drilled pilot holes as shown.

STEP 8

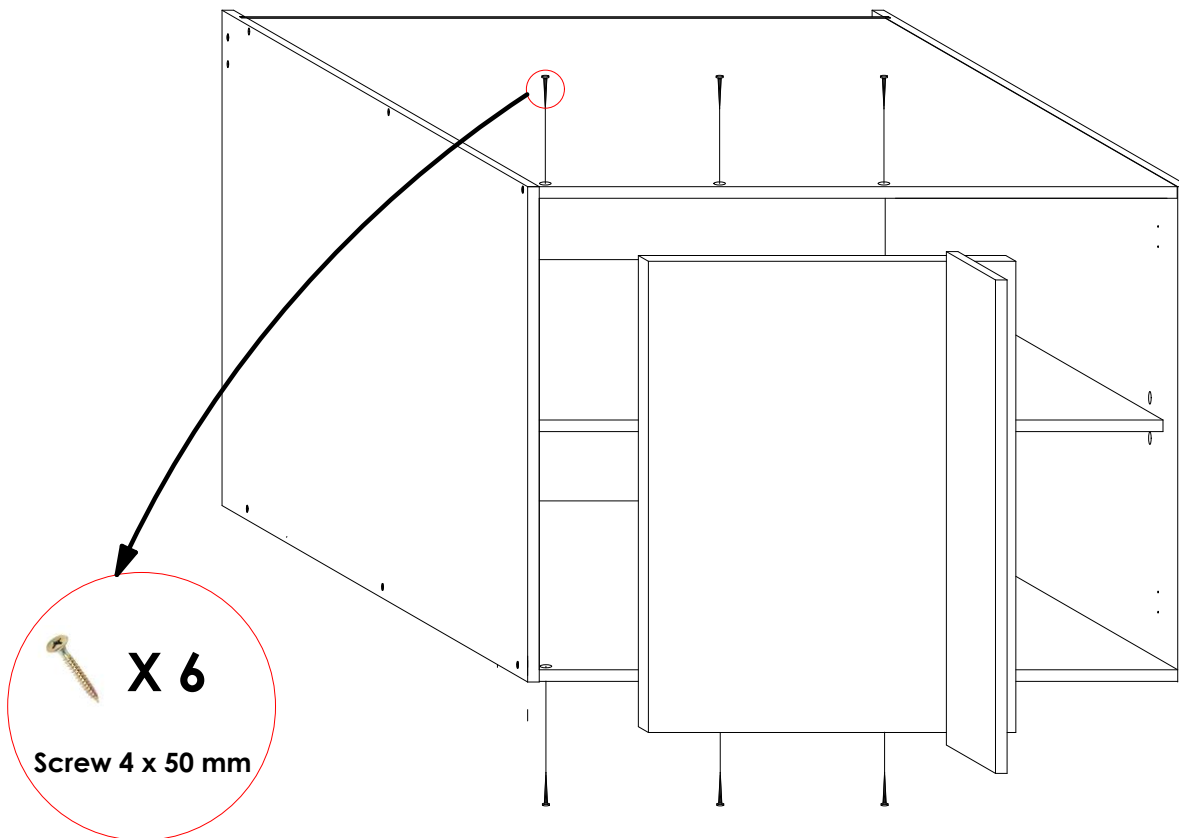

Connect panel **I** to panels **B** and **D** using **Screw 4.0 X 50mm** in the pre-drilled pilot holes as shown.

STEP 9

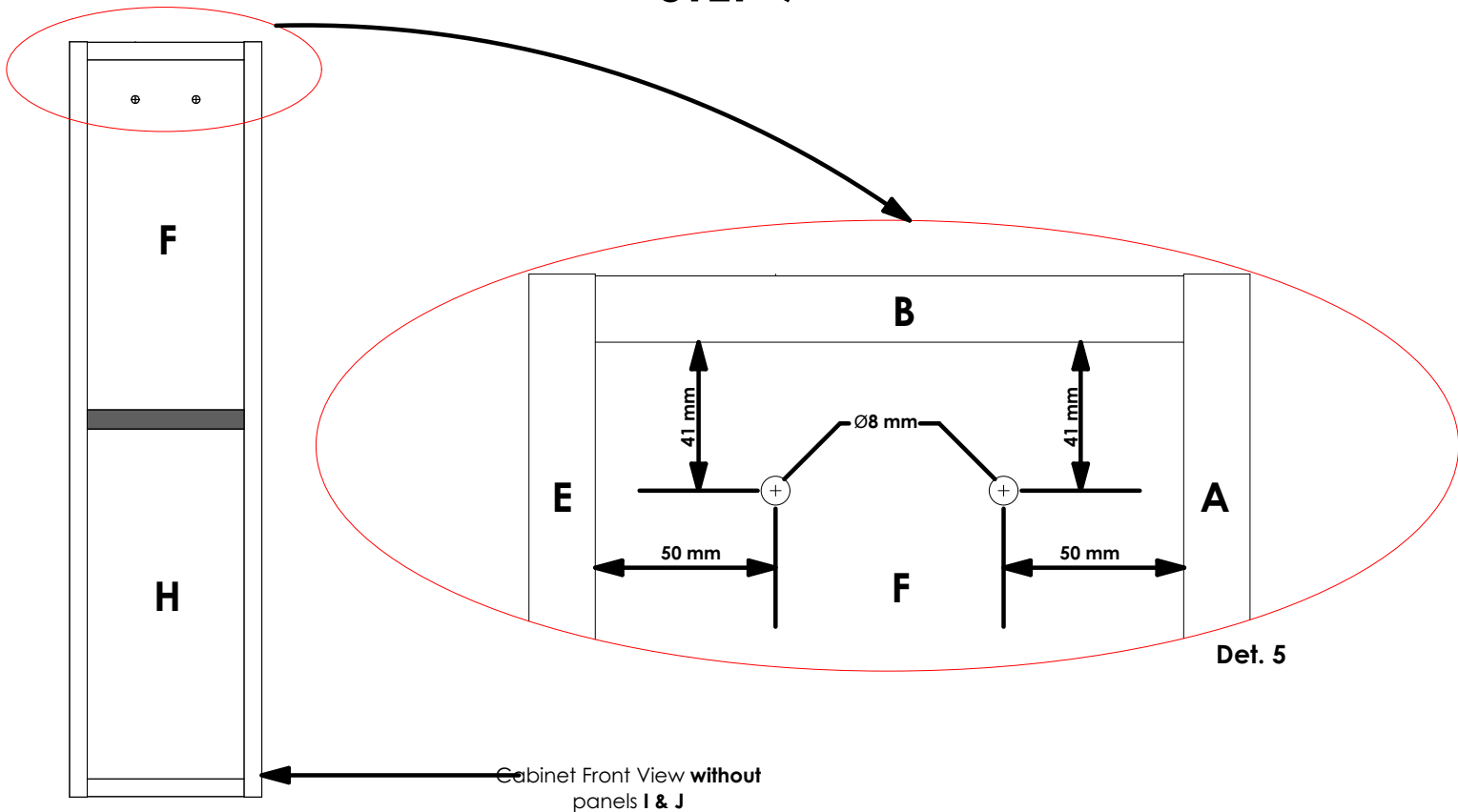

Using an **8mm** Drill Bit, gently drill two holes **through** panels **F & C** in the positions shown in **Det. 5**. **Countersink** the holes such that the **Screw Head** will be **flush** with the surface of panel **F**.

STEP 10

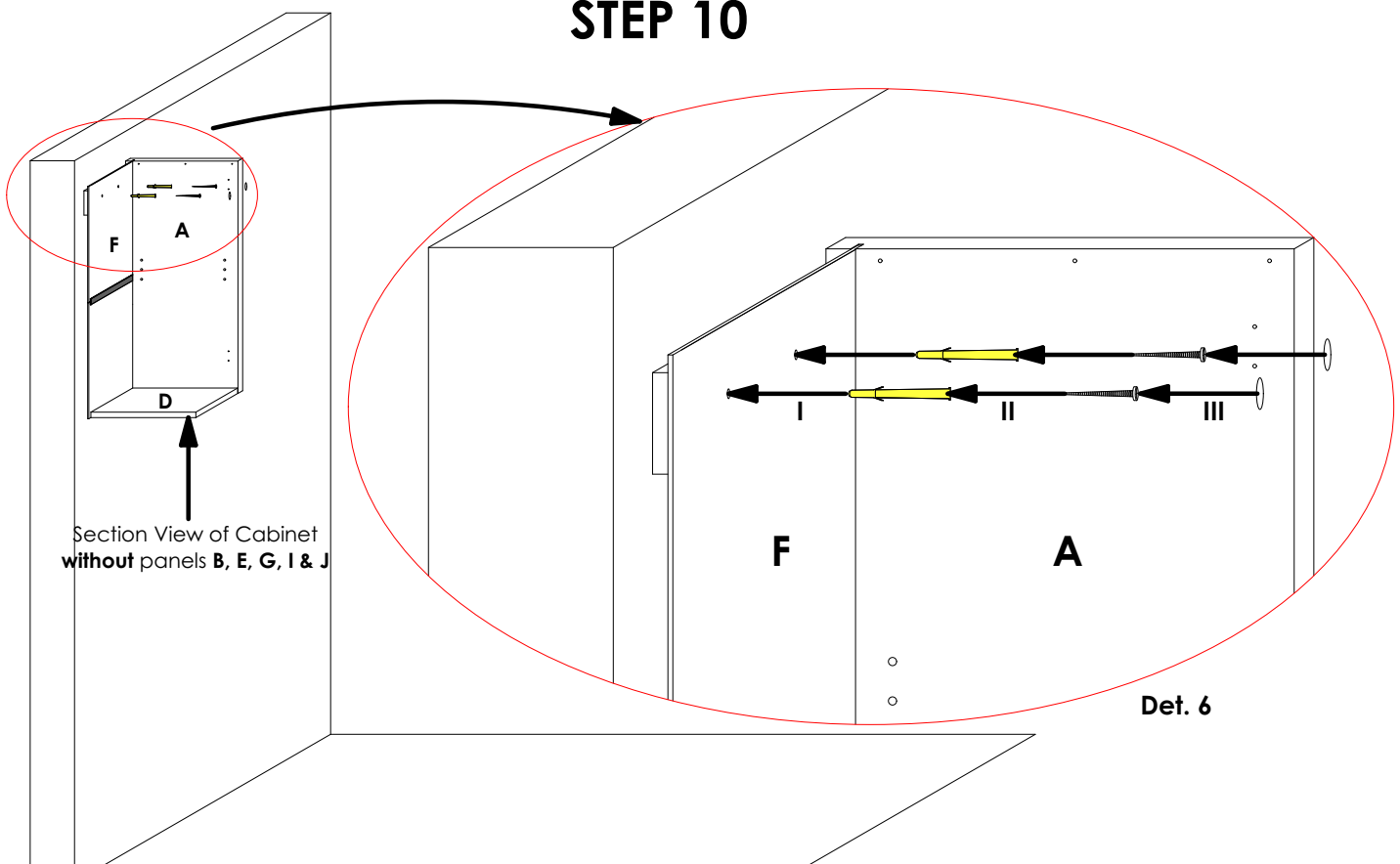

- Raise the cabinet on the wall up to the desired level. Mark the drill points on the wall through the holes drilled in **Step 4** ensuring that the cabinet is both **upright** and **level**.
- Lower the cabinet and using an **8mm drill bit**, drill **80mm deep** holes on the wall, through the marked points.
- Separate the **yellow plug** from the nail in anchor.
- Raise the cabinet and using a **rubber mallet**, gently knock in the plug through panels **F & C** and into the **wall** (See **Det. 6**).
- Screw the **nail in anchor** into the **yellow plug** ensuring that the **screw head** is **flush** with the surface of panel **F** (See **Det. 6**).
- Stick the **Screw Caps** onto the **screw heads** to conceal them (See **Det. 6**).
- See **Door Installation Guide** for further instructions.