

KINETIC FLATPAX RANGE

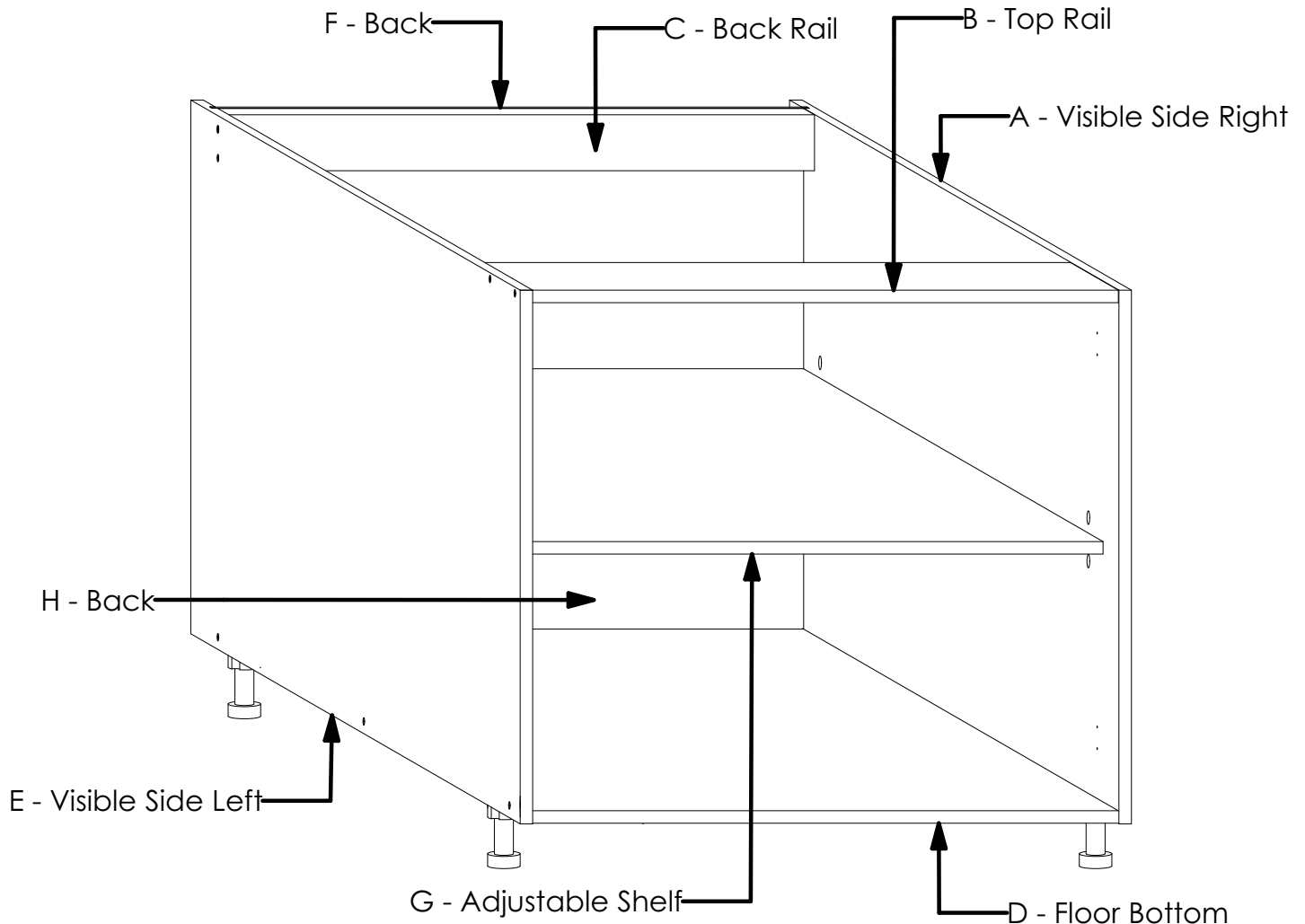



ASSEMBLY GUIDE

BASE CABINET 600mm



TOTAL NUMBER OF PANELS: 8

HARDWARE

PRODUCT	QTY	IMAGE
Screw 4.0 x 50mm	14	
Shelf Studs	4	
Screw 3.5 x 16mm	22	
Plinth Leg With Base H100mm Kit	4	
H Profile Backer Connector	1	

GENERAL INSTRUCTIONS

1. Confirm that all panels (8) are in the package before assembling.
2. Check the white sticker on each panel for the labelling (A, B, C, D, E, F, G & H).
3. Ensure that the panels are laid on a non-abrasive surface when assembling.
4. Countersink the holes on the side panels before inserting the screws.
5. Ensure that the screw is perpendicular to the surface being drilled for a clean and strong joint.

TOOLS REQUIRED



Screw Driver
(Pozidriv Head)



Cordless Drill

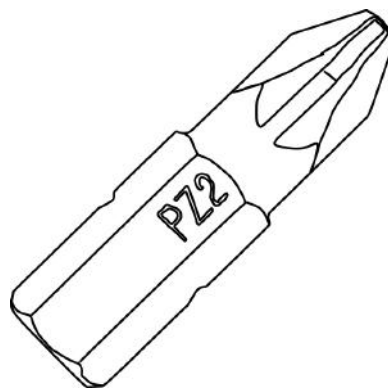

Pozi Bit (PZ2)

STEP 1

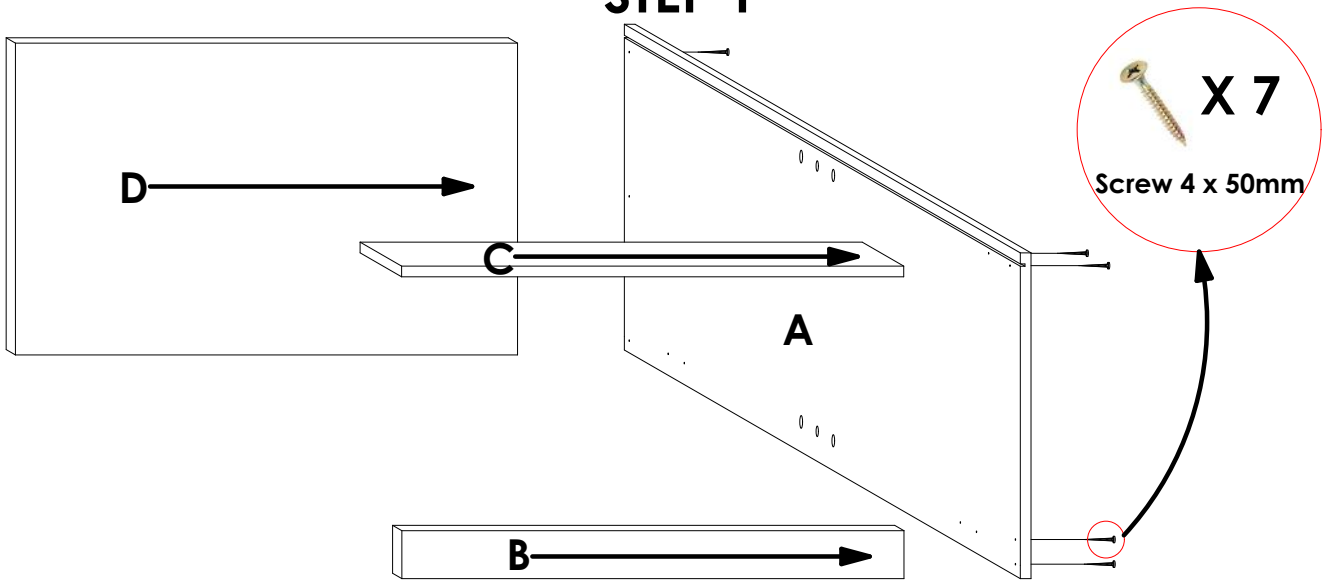

Connect panels **B, C & D** to panel **A** using **Screw 4.0 X 50mm** in the pre-drilled pilot holes as shown. Refer to **Det 1 - 3** below before fastening the screws.

STEP 2

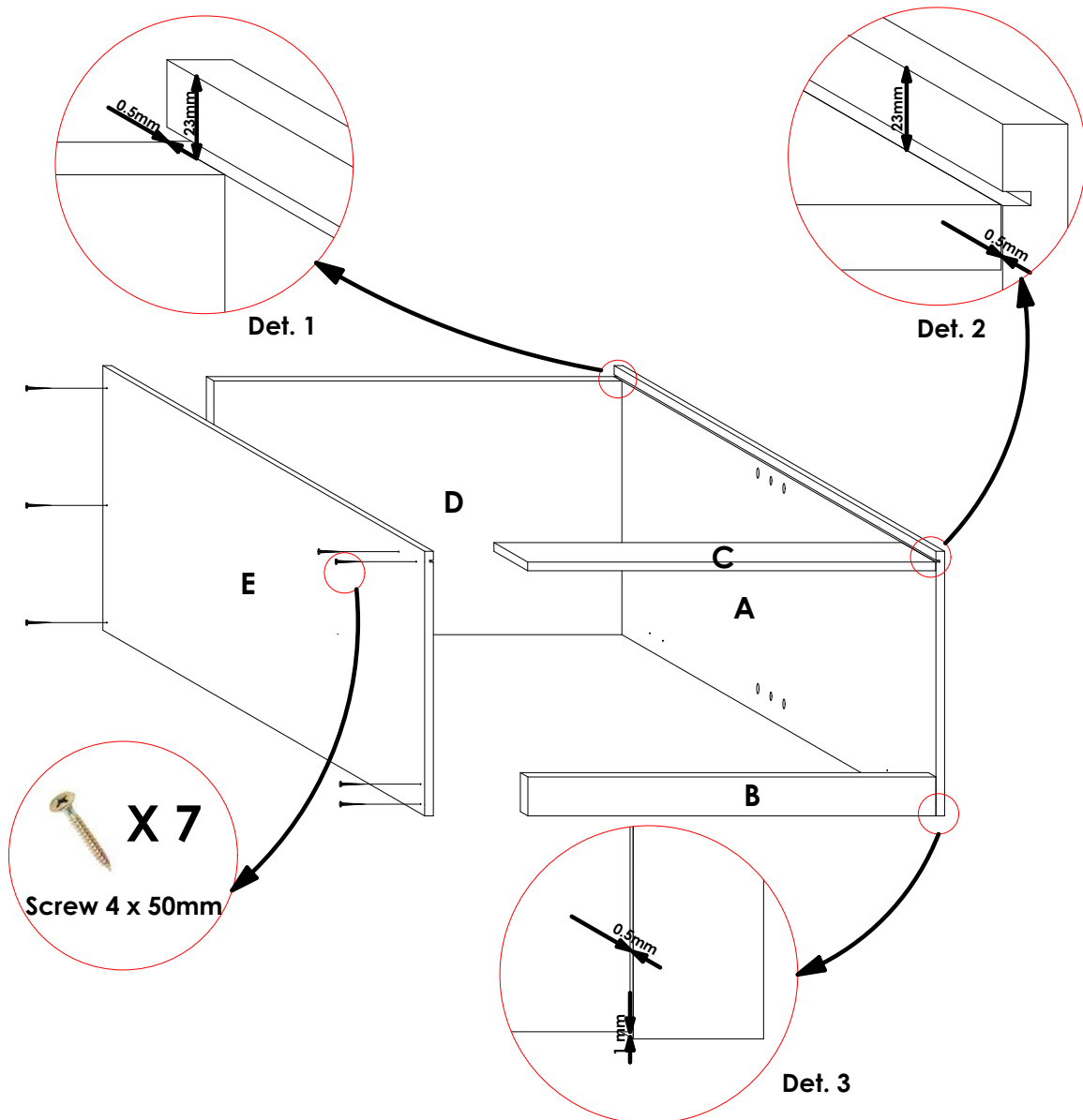

Connect panel **E** to panels **B, C & D** using **Screw 4.0 X 50mm** in the pre-drilled pilot holes as shown. Ensure that the **symmetry** between panel **E** and panel **A** is maintained. Refer to **Det 1 - 3**.

STEP 3

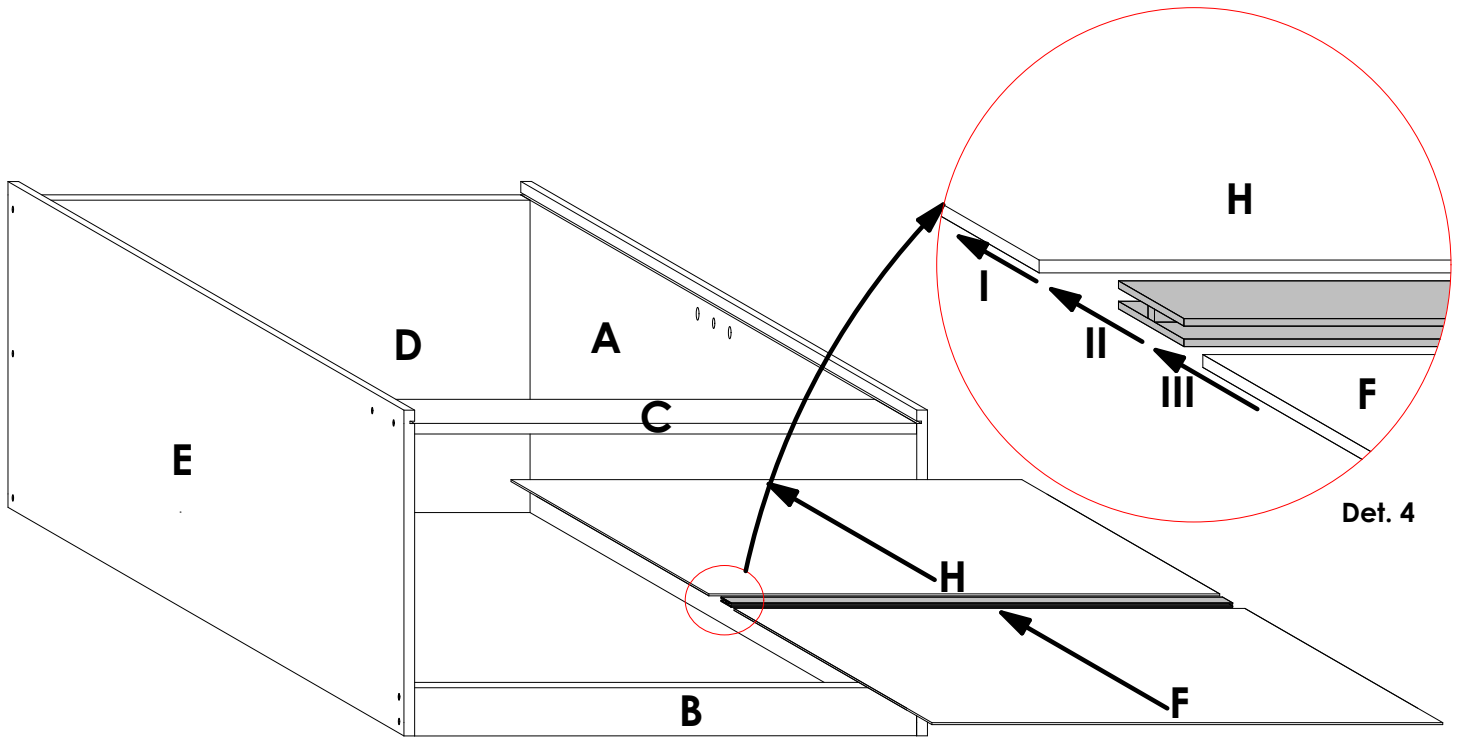

Slide 3mm panel **H** into the groove on panels **A & E** with the finished side facing inside the cabinet. After, insert the **H Profile Backer Connector** into panel **H** as shown (See **Det. 4**). To finish this step, slide 3mm panel **F** into the groove on panels **A & E** and into the **H Profile Backer Connector** as shown in **Det. 4**.

STEP 4

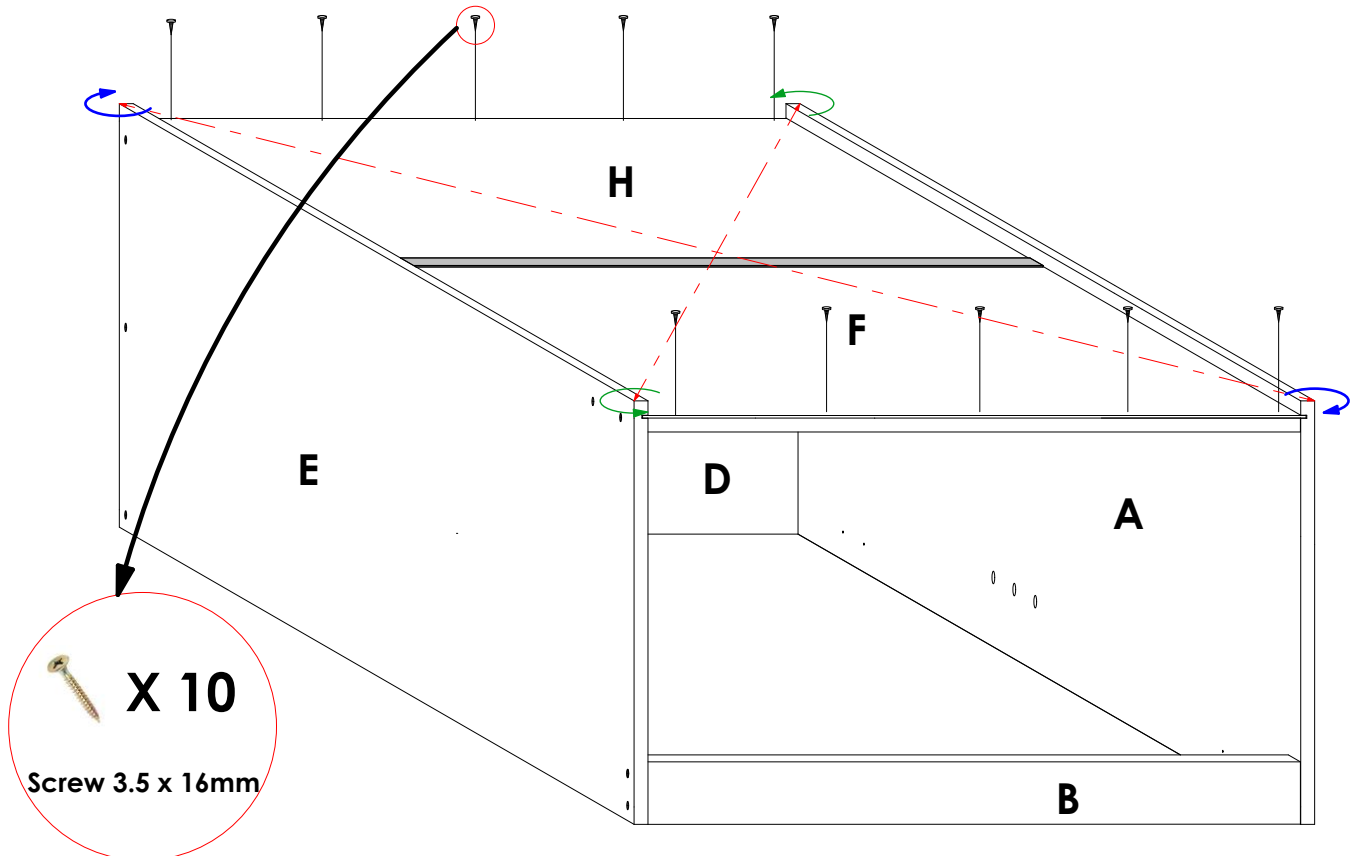

First, **check the diagonal** of the cabinet by measuring the two distances indicated by the broken lines. They should be equal. If not, twist the cabinet accordingly in the diagonal corners as shown until an equal value is achieved. After, secure panels **F & H** to panels **C & D** respectively as shown using **Screw 3.5 X 16mm**.

STEP 5

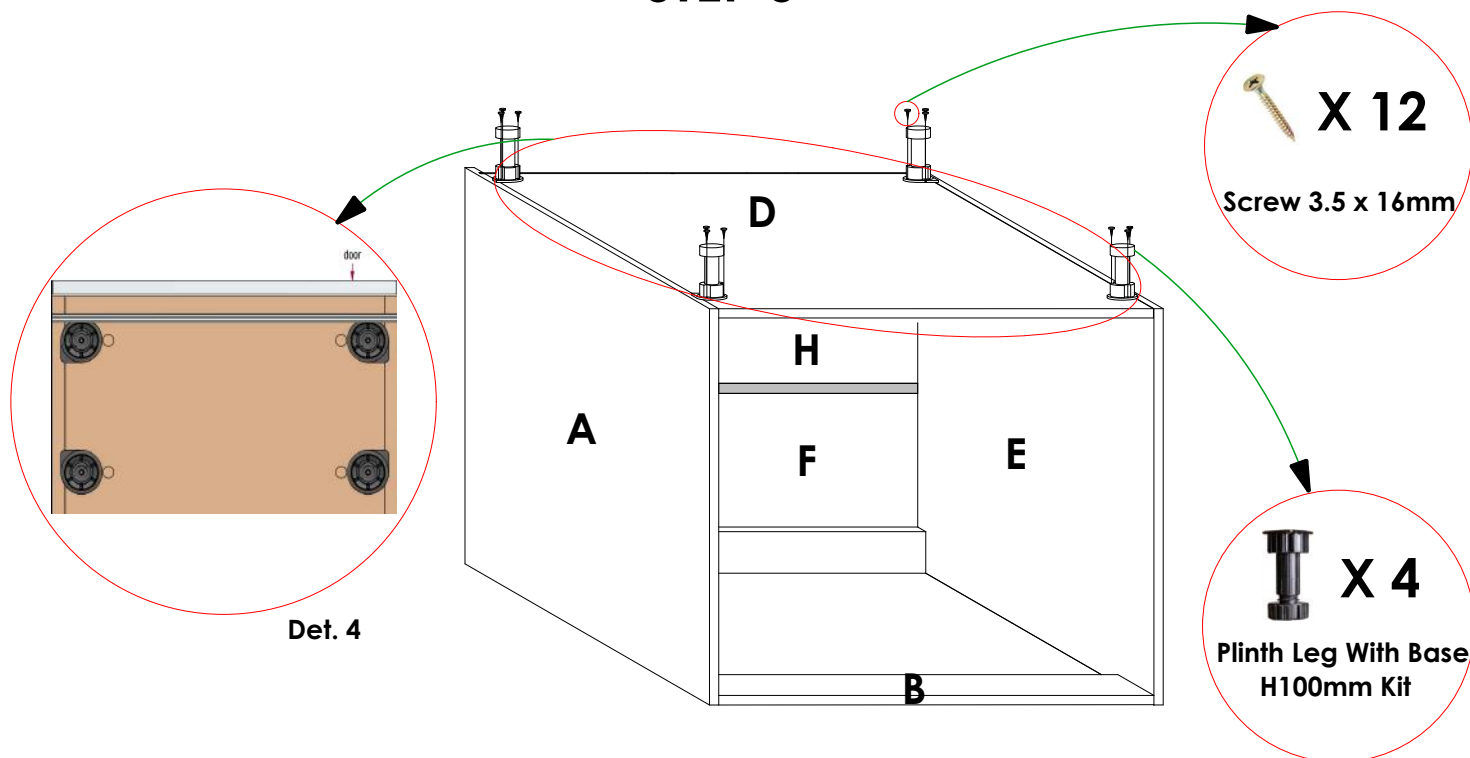

Flip the cabinet up-side down as shown. Place the four units of **Leg Adjustable Base 100mm** in the shown positions, aligning with the pre-drilled pilot holes on panel **D**. Ensure that the orientation is as shown in **Det. 4**. Using **Screw 3.5 X 16mm**, secure the legs onto panel **D**.

STEP 6

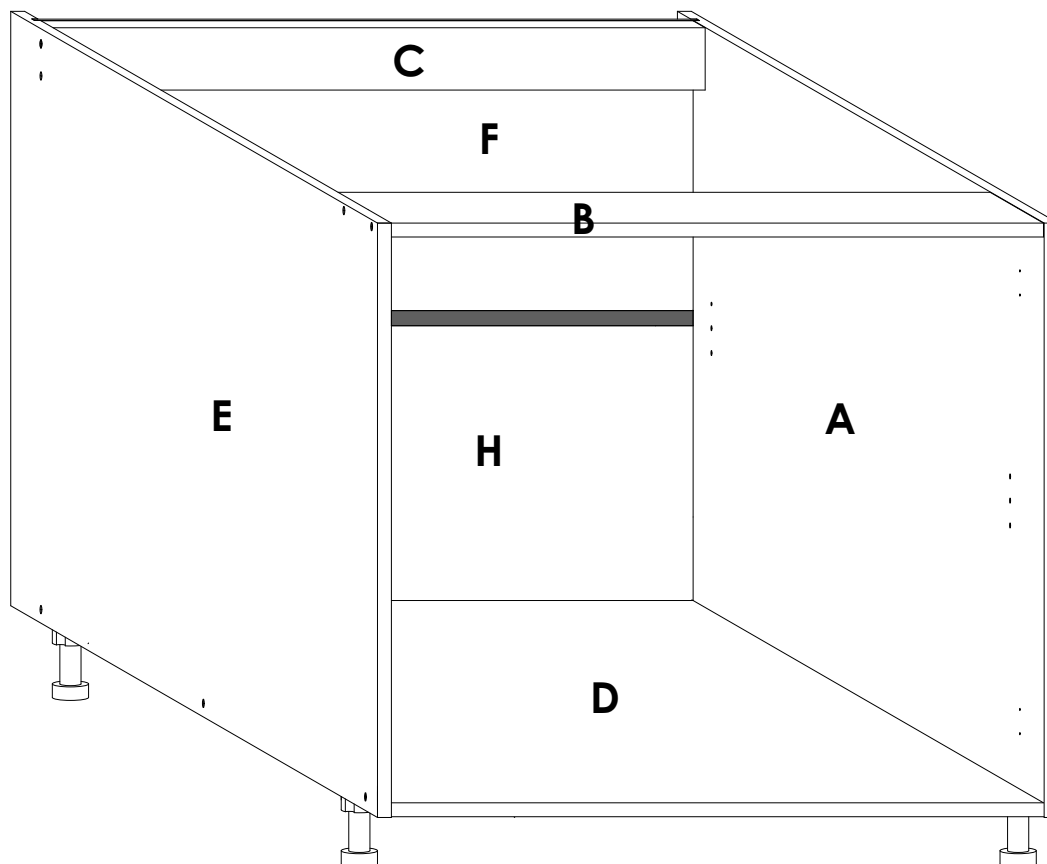

Flip the cabinet upright down as shown and confirm that the legs are secured firmly.

STEP 7

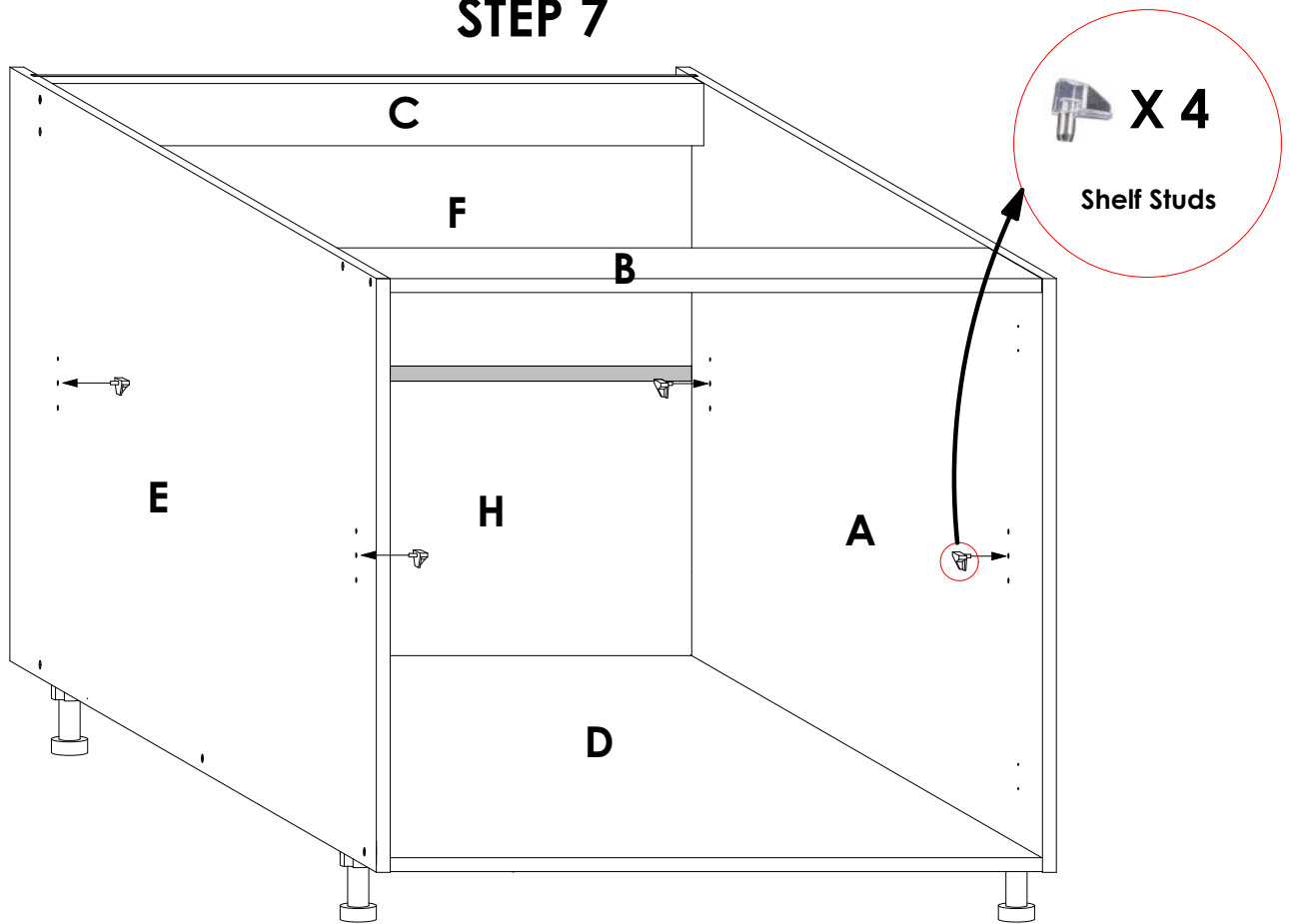

Insert the **Shelf Studs** in the shown positions.

STEP 8

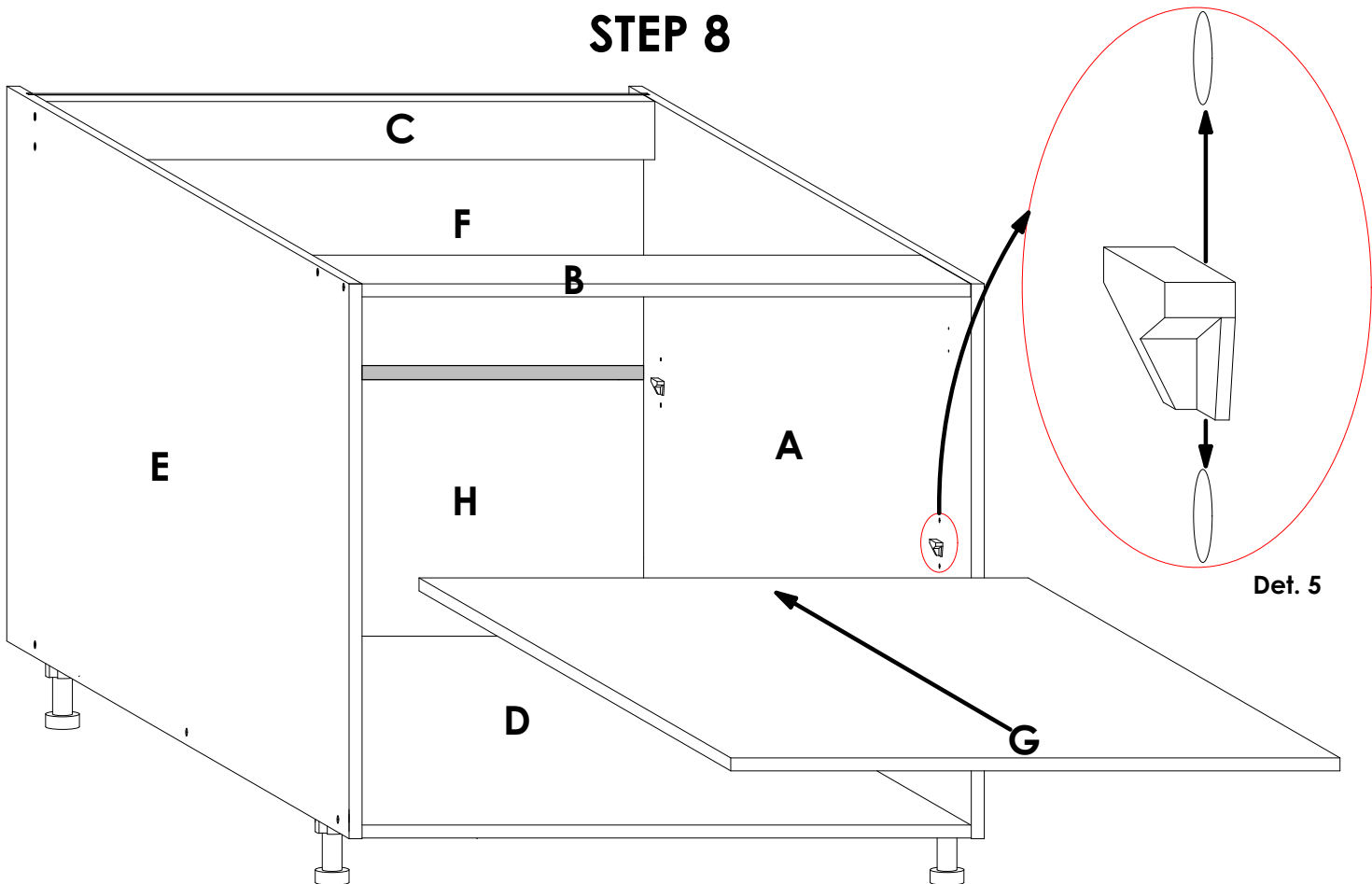

Slide in panel **G** as shown, such that it sits on the four shelf studs. The level of the shelf is adjustable by shifting the position of the shelf studs as shown in **Det. 5**. See Door Installation Guide for further instructions.