

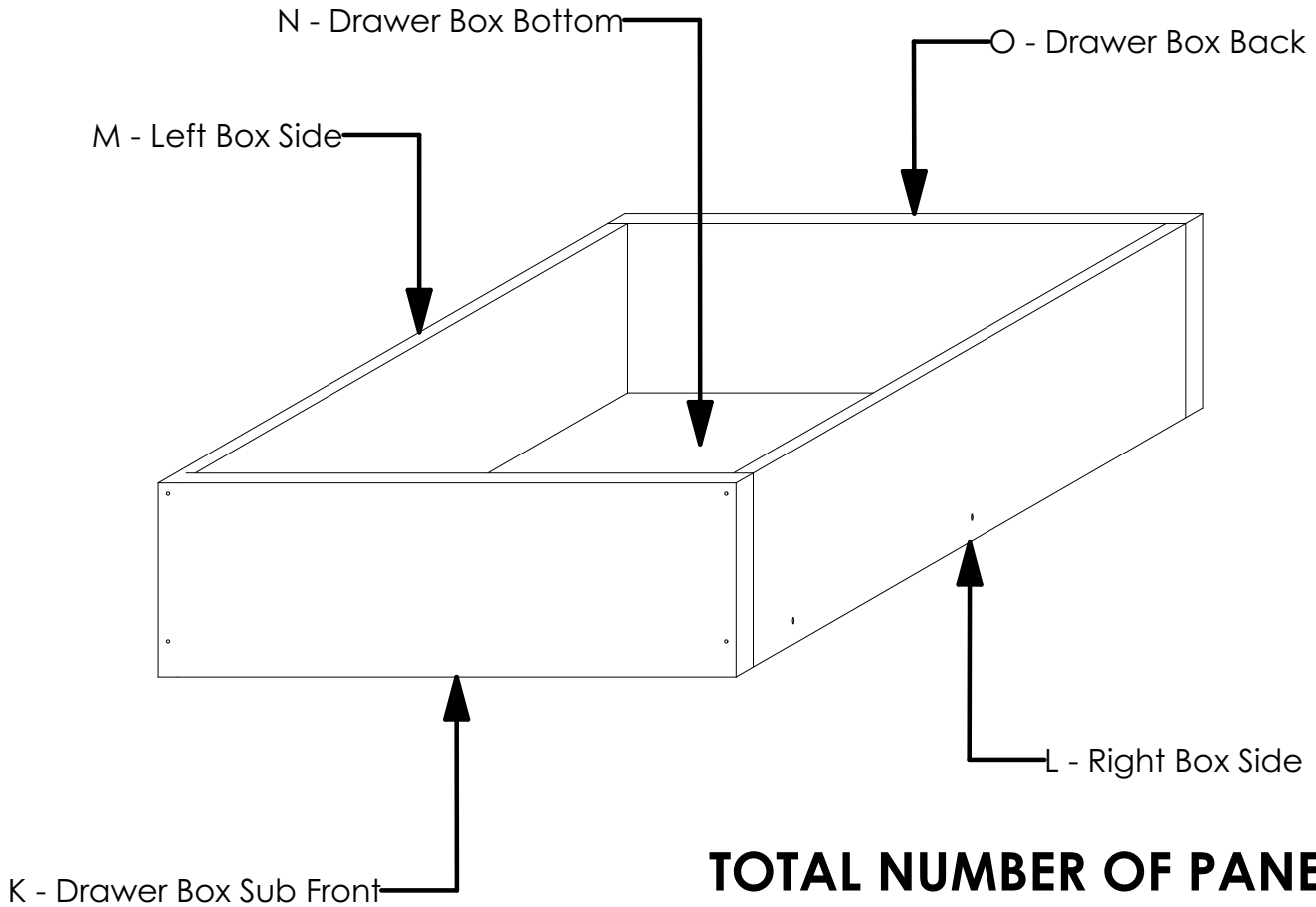



KINETIC FLATPAX RANGE

ASSEMBLY GUIDE

DRAWER BOX HEIGHT 1



HARDWARE

PRODUCT	QTY	IMAGE
Screw 4.0 x 50mm	8	
Full Extension Slide 45 x 500mm Soft-Close	1 Pair	
Screw 3.5 x 16mm	12	

GENERAL INSTRUCTIONS

1. Confirm that all panels (5) are in the package before assembling.
2. Check the white sticker on each panel for the labelling (K, L, M, N & O).
3. Ensure that the panels are laid on a non-abrasive surface when assembling.
4. Countersink the holes on the Sub-front (Panel K) and Back (Panel O) before inserting the screws.

TOOLS REQUIRED



Screw Driver
(Pozi Drive Head)



Cordless Drill



Pozi Bit (PZ2)

STEP 1

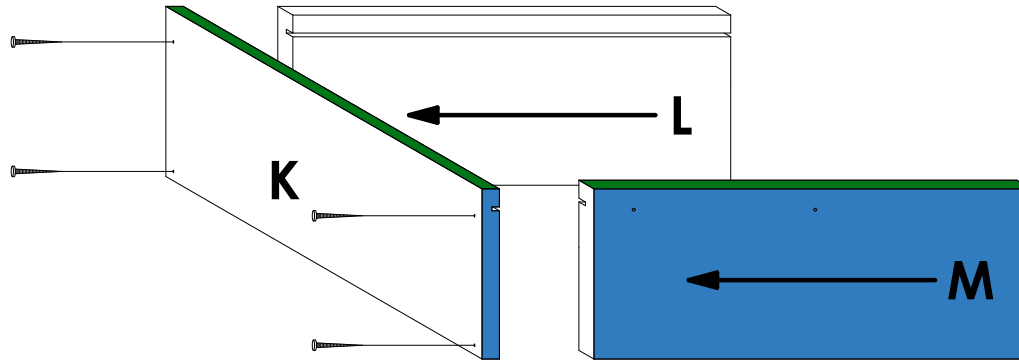

Connect panels **L & M** to panel **K** using **Screw 4.0 X 40mm/50mm** in the pre-drilled pilot holes as shown. The top edges should be **flush** with each other. Also, the right and left edges of panel **K** should be **flush** with the outside faces of panels **M & L**. Ensure that the screw is perpendicular to the surface being drilled for a clean and strong joint.

STEP 2

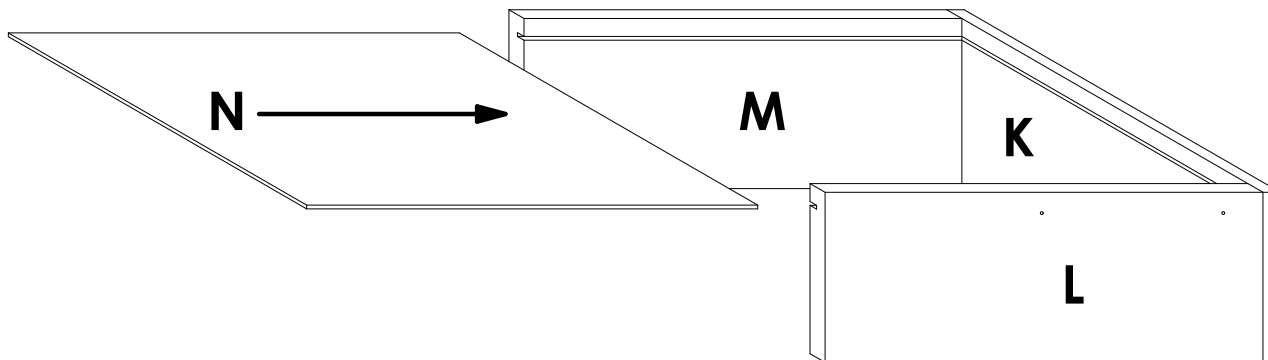

Slide 3mm panel (**N**) through the groove on panels **L & M** and into the groove on panel **K**, with the finished side facing down.

STEP 3

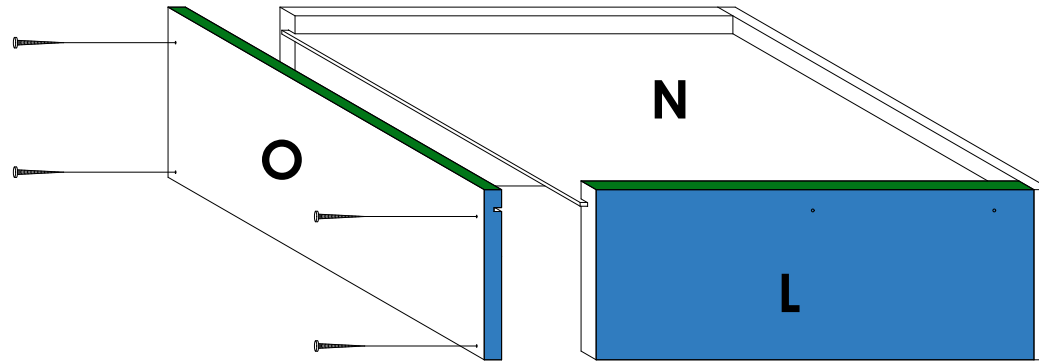

Connect panel **O** to panels **L & M** using **Screw 4.0 X 40mm/50mm** in the pre-drilled pilot holes as shown. The top edges should be **flush** with each other. Also, the right and left edges of panel **O** should be **flush** with the outside faces of panels **M & L**. Ensure that the screw is perpendicular to the surface being drilled for a clean and strong joint.

STEP 4

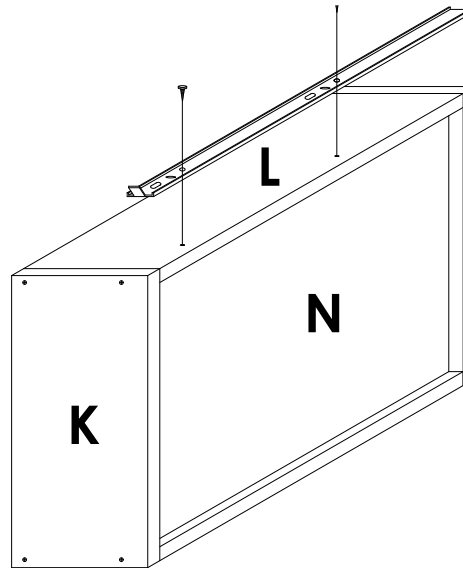

Separate the **Full Extension Slide 45mm X 500mm** and connect the piece shown (**runner**) on panel **L** using **Screw 3.5 X 16mm**. Use the pilot holes provided to set the runner position. Add a minimum of one more screw when done. Ensure that the orientation of the drawer box and runner is as shown.

STEP 5

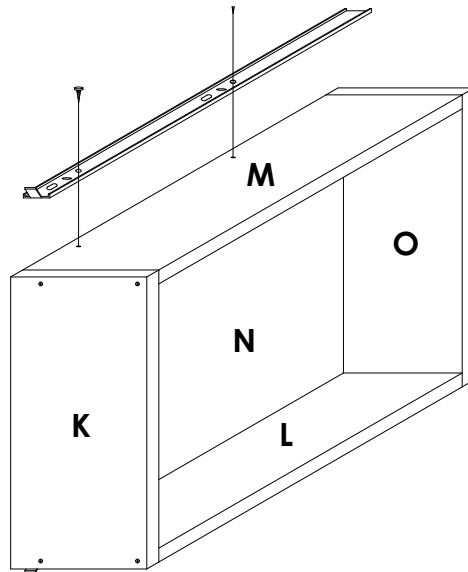

Repeat **Step 4** for panel **M**.

STEP 6

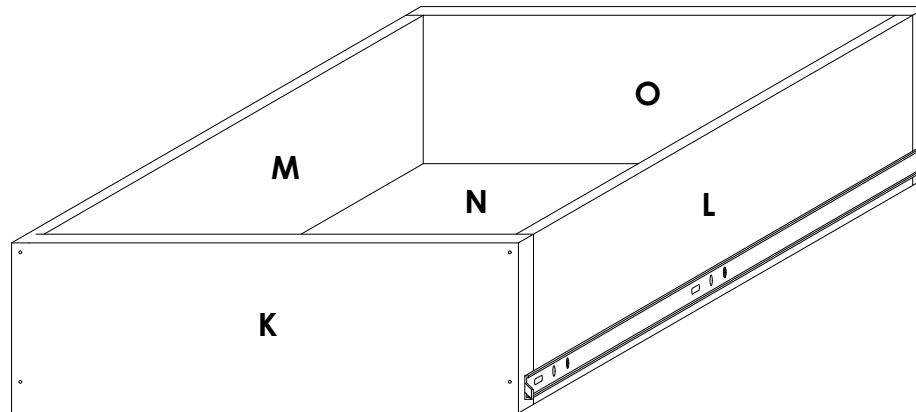

Continue as per the Assembly Guide for the **Base Cabinet - Draw** units.