

# BLUM FLATPAX KITCHEN RANGE

## ASSEMBLY GUIDE

### WALL CABINET FLAP 600mm

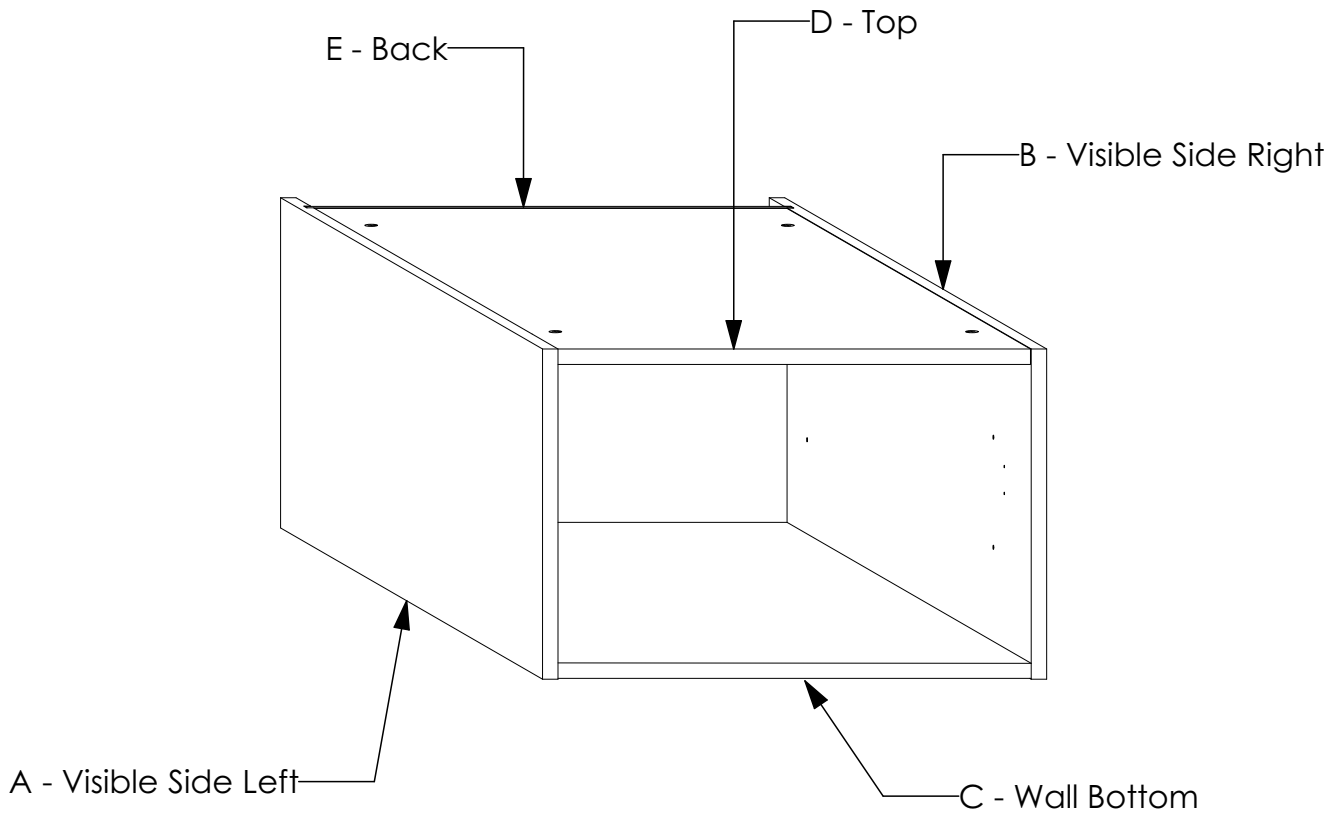

**TOTAL NUMBER OF PANELS: 5**

#### HARDWARE

PRODUCT	QTY	IMAGE
Sys5 Quickfit TL2 Dowel 8 x 34	8	
Sys5 Cam 3000 15 x 14 mm	8	
Wooden Dowel Titus 8 x 30 mm	16	
Screw 3.5 x 16mm	12	
Screw 4.0 x 30mm	2	
APC 1 Wall Cabinet Hanger Kit	1	
Screw Nail in Anchor 8 x 80mm Yellow	4	
Cabinet Connecting Screw Kit	4	
Shelf Support Flipper 14mm Kit	4	

## TOOLS REQUIRED



Screw Driver  
(Pozi Drive Head)



Cordless Drill

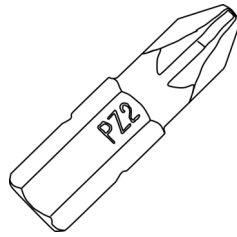

Pozi Bit (PZ2)



8mm Drill Bit



Rubber Mallet

## GENERAL INSTRUCTIONS

1. Confirm that all panels (6) are in the package before assembling.
2. Check the white sticker on each panel for the labelling (A, B, C, D, E & F).
3. Ensure that the panels are laid on a non-abrasive surface when assembling.
4. Note that all panel connections are done using the system described below.

## PANEL CONNECTION AND FASTENING

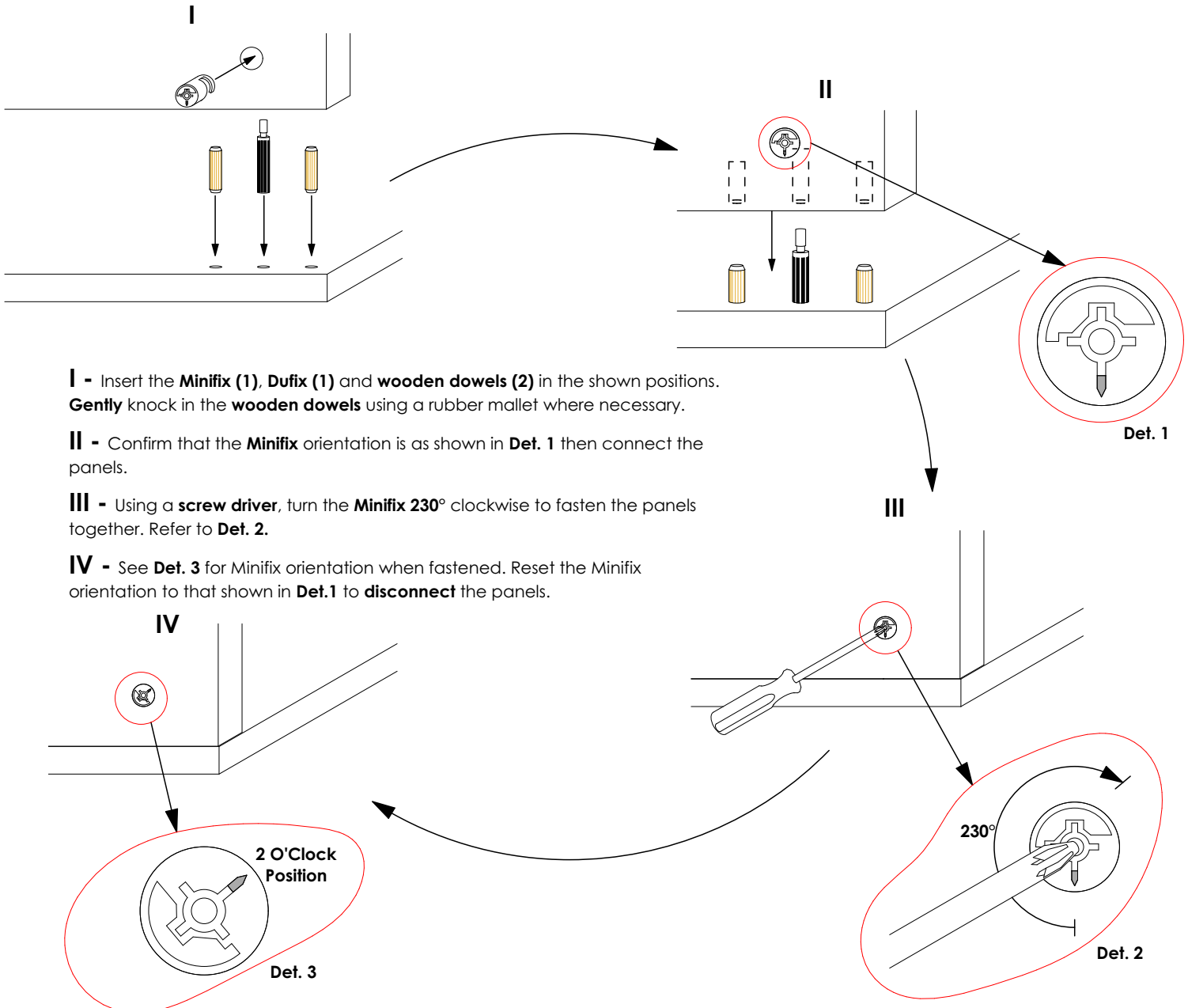

# PILOT HOLES KEY FOR SIDE PANELS

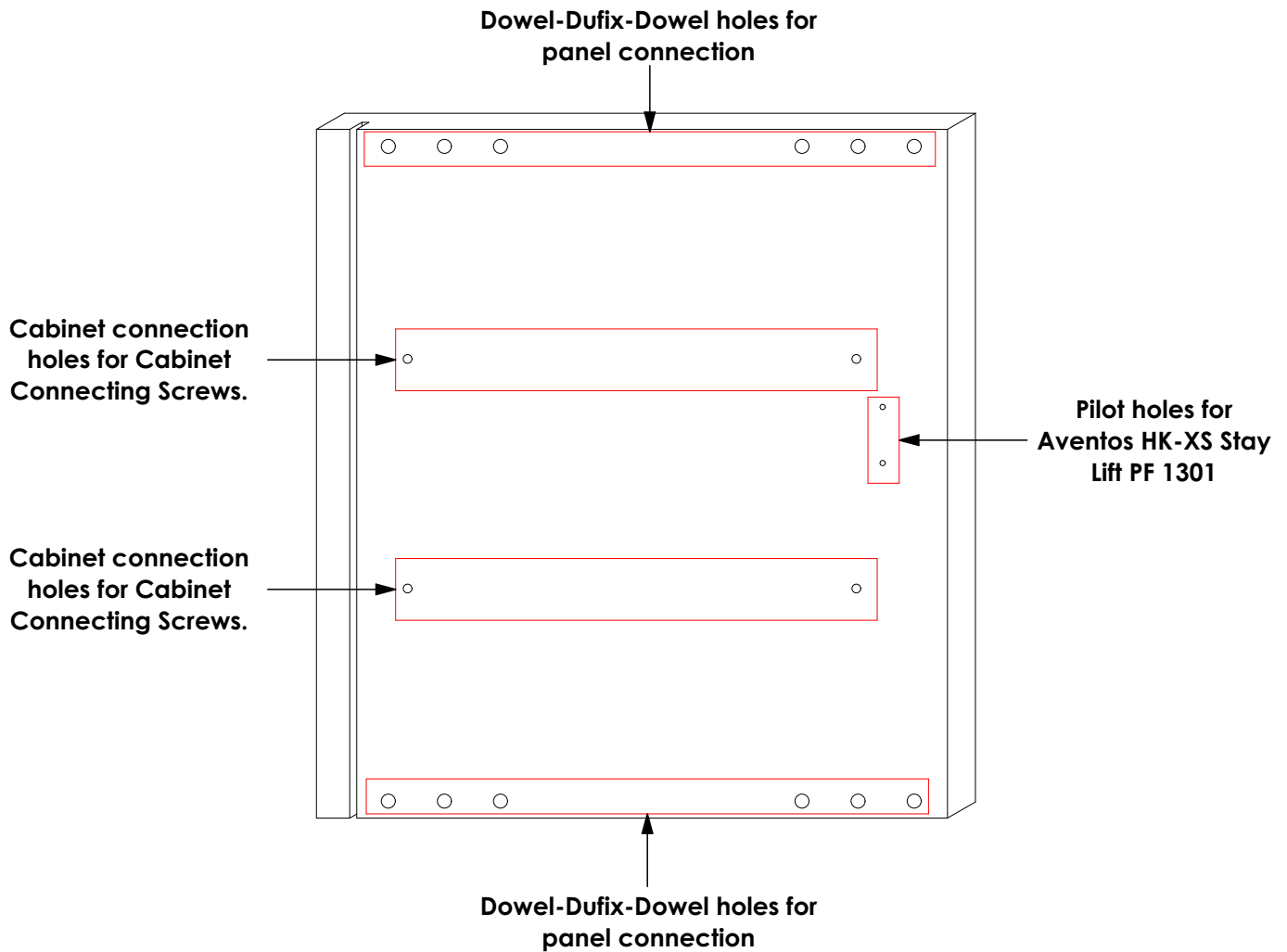

# PILOT HOLES KEY FOR TOP PANEL

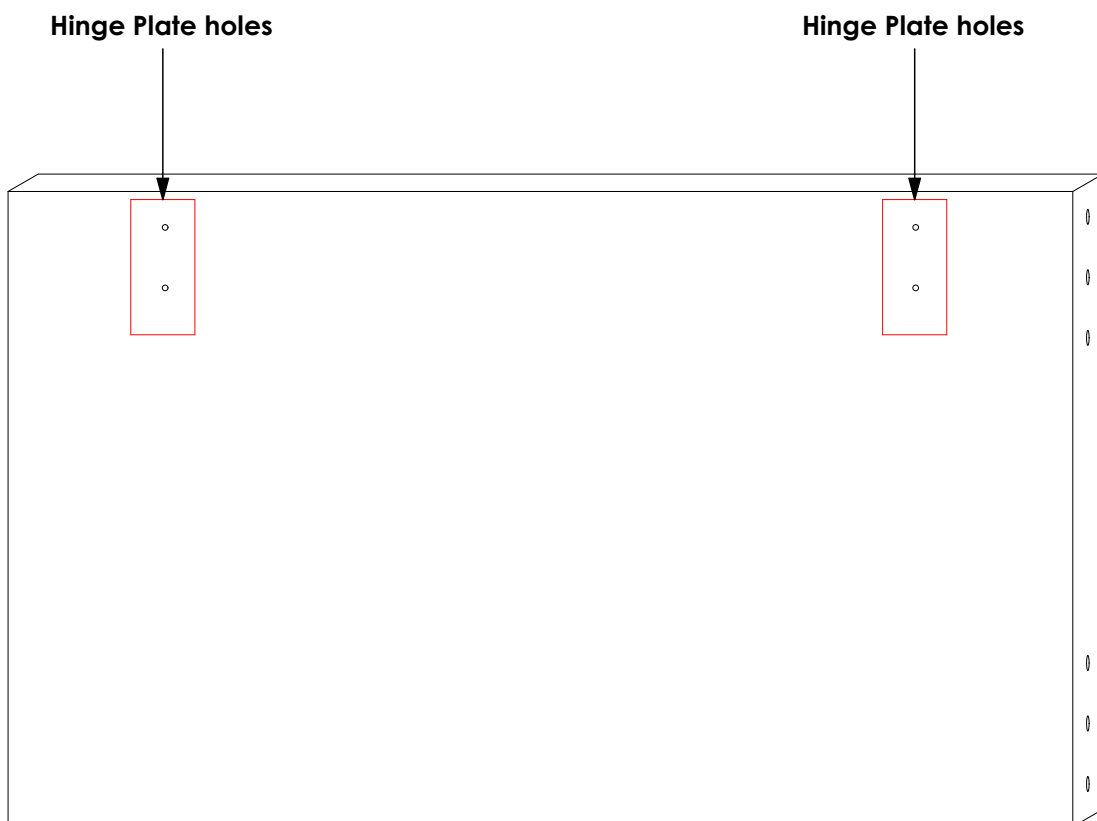

## STEP 1

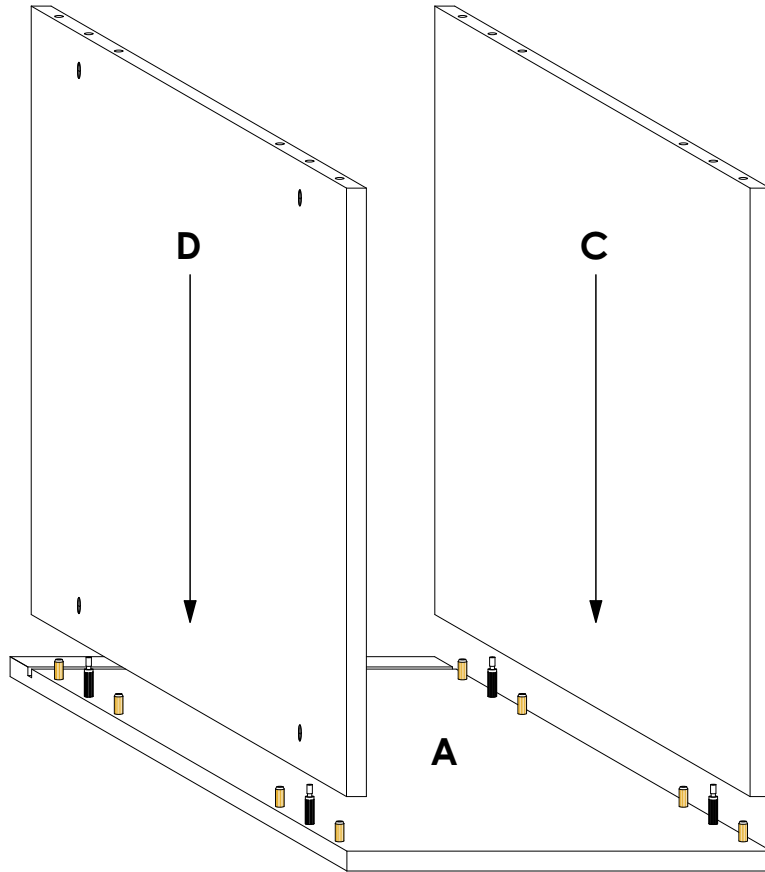

Connect panels **C & D** to panel **A** as shown. Refer to the holes and/or grooves on the diagram to determine the panel orientation.

## STEP 2

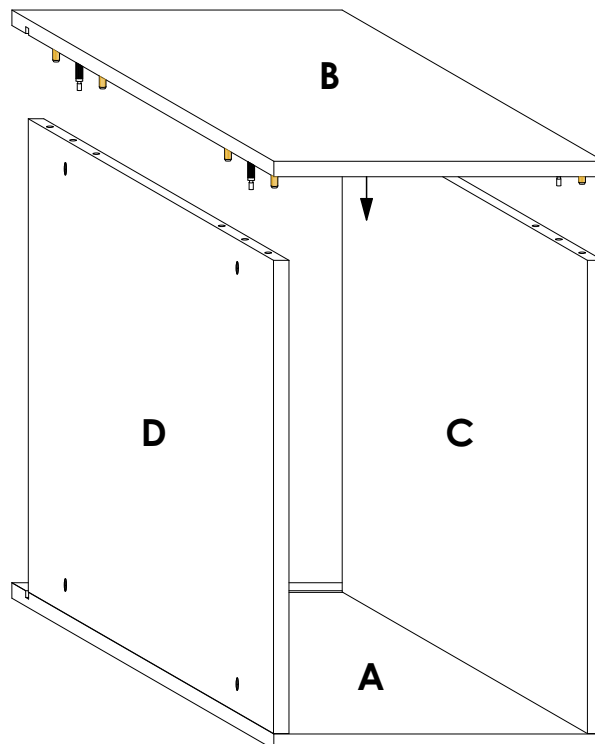

Connect panel **B** to panels **C & D** as shown. Refer to the holes and/or grooves on the diagram to determine the panel orientation.

## STEP 3

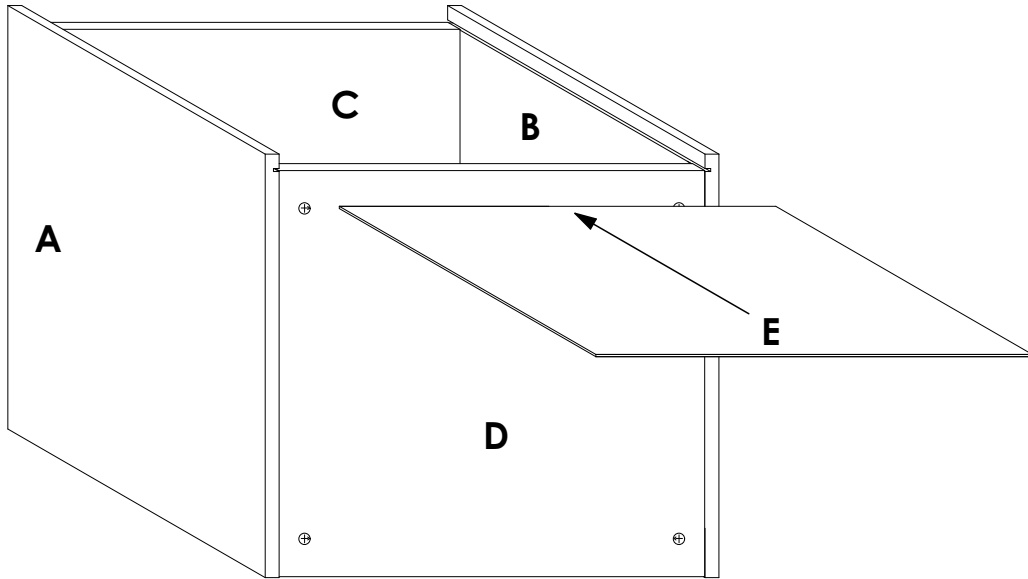

Slide **3mm** panel **E** through the grooves on panels **A & B** as shown. Refer to the holes and/or grooves on the diagram to determine the panel orientation.

## STEP 4

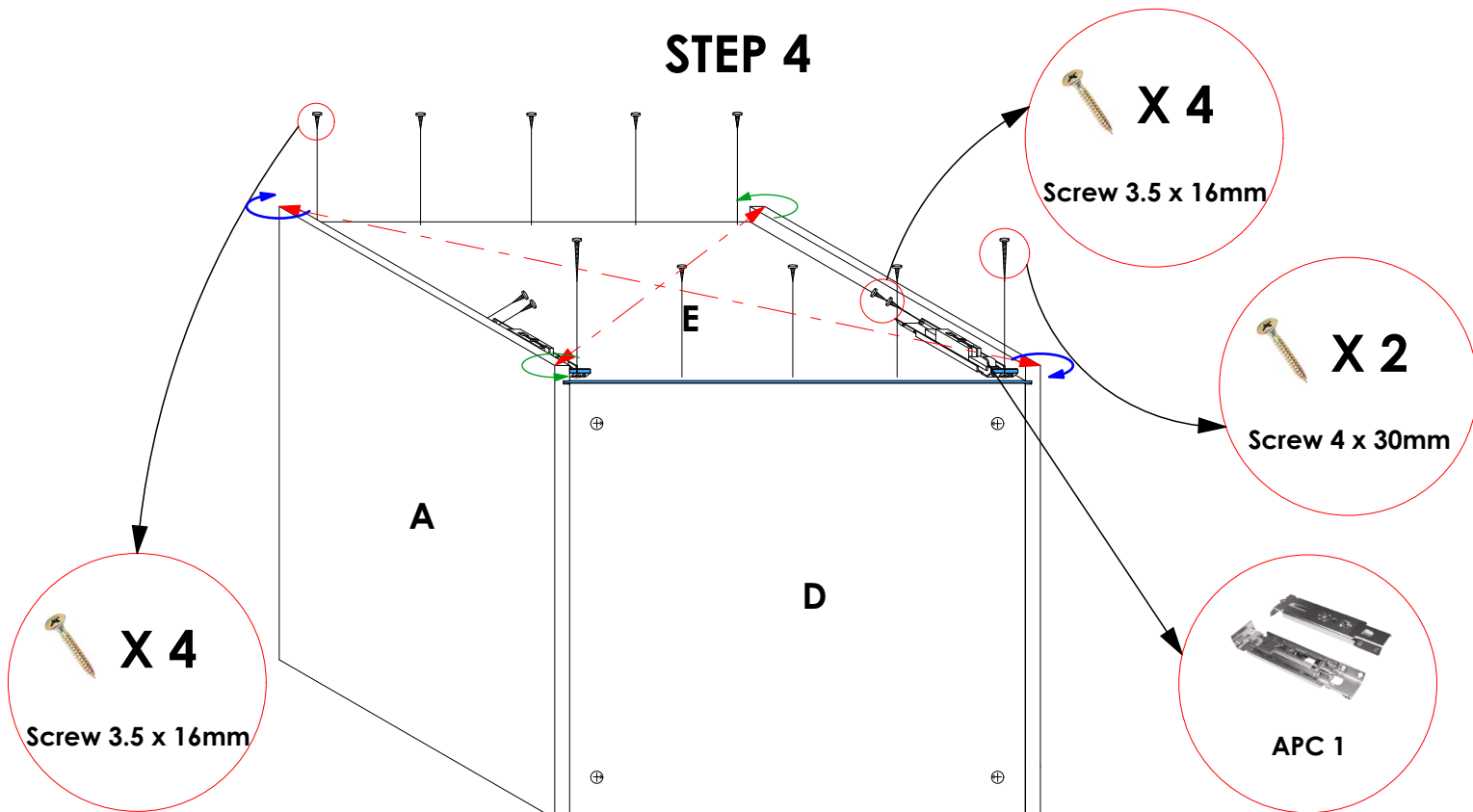

First, **check the diagonal** of the cabinet by measuring the two distances indicated by the red, broken lines. They should be equal. If not, twist the cabinet accordingly in the diagonal corners as shown until an equal value is achieved. After, place the **APC 1** hangers in the shown positions ensuring that the shaded areas are flush with each other. Then, secure panel **E** to panel **C** using **Screw 3.5 X 16mm** and to panel **D**, through the **APC 1** hangers, using **Screw 4 X 30mm**. Reinforce the **APC 1** hangers and panel **E** in the shown positions using **Screw 3.5 X 16mm**.

## STEP 5

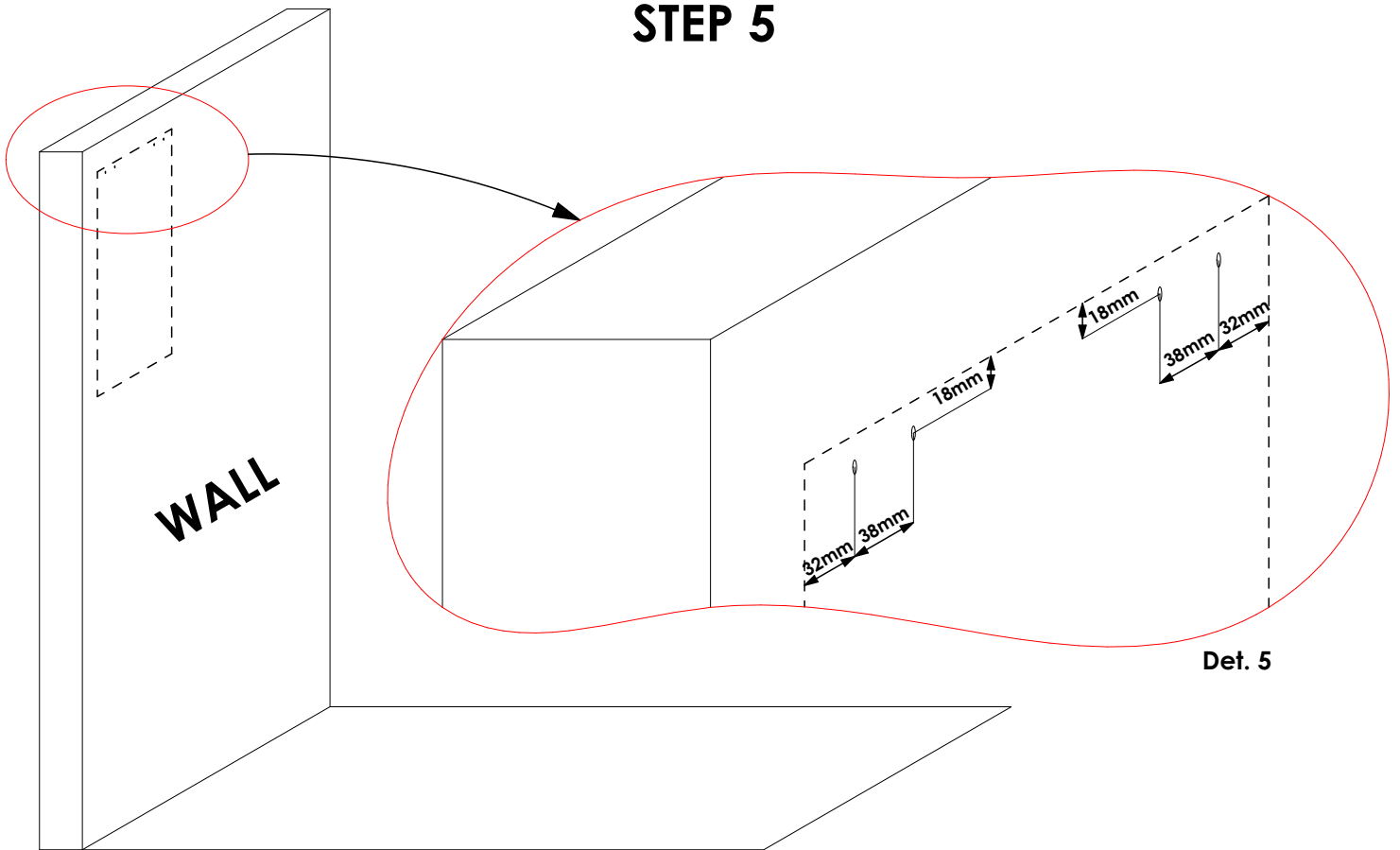

The **broken lines** indicate the **outer boundaries** of the **wall cabinet**. Mark the drill points on the wall with respect to the hanging position of the wall cabinet. Refer to **Det. 5** for dimensions. Then, using an **8mm Drill Bit**, drill **80mm deep** holes through the marked positions on the wall ensuring that the **drill bit is perpendicular to the wall surface**.

## STEP 6

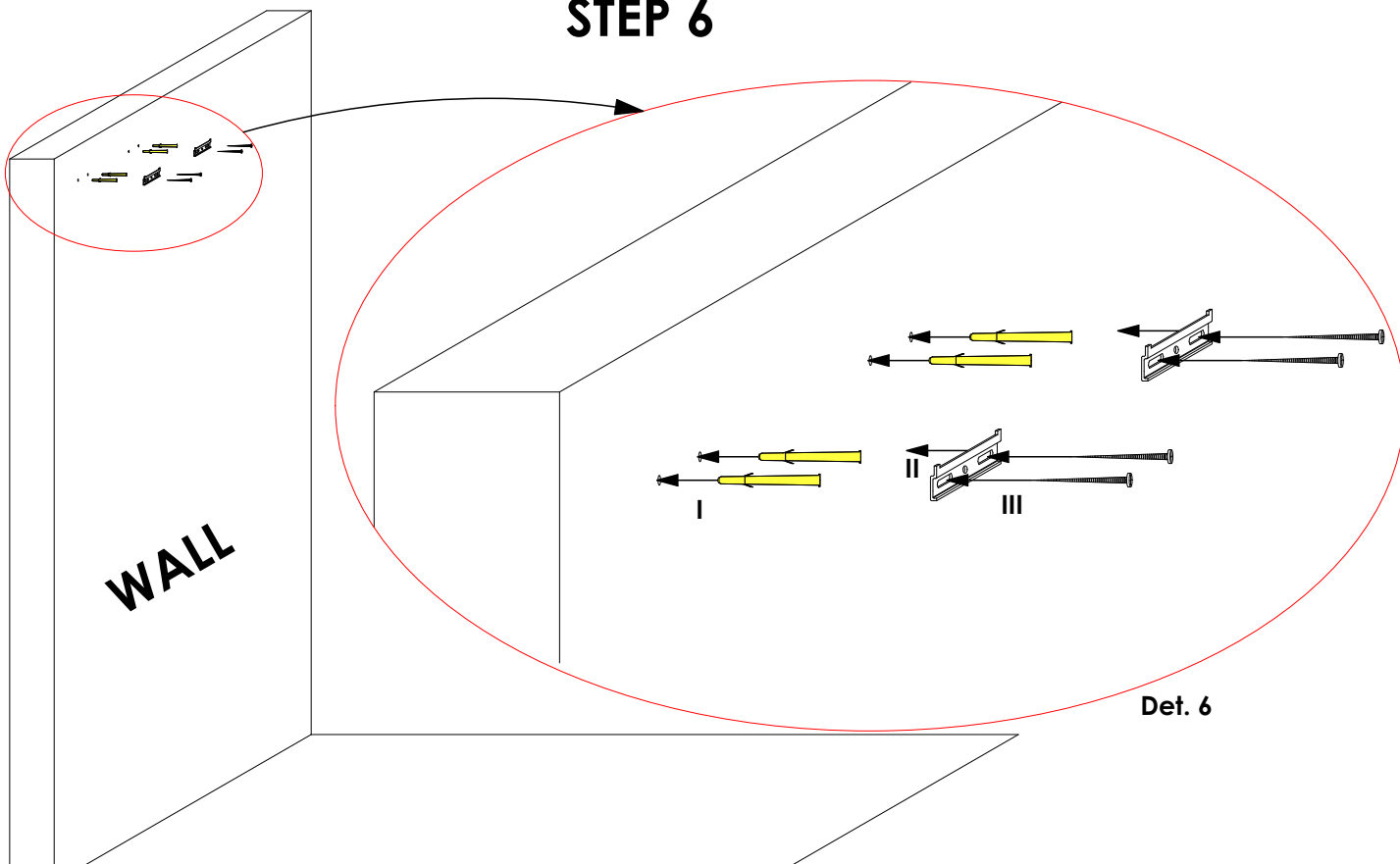

- I) Separate the **yellow plug** from the **nail in anchor** and, using a **rubber mallet**, **gently** knock in the plug into the holes drilled in **Step 5**.
- II) Place the **APC 1 wall plates** on the wall. Align the oval holes on the wall plate with the plugs.
- III) Screw the **nail in anchor** into the **yellow plug**.

## STEP 7

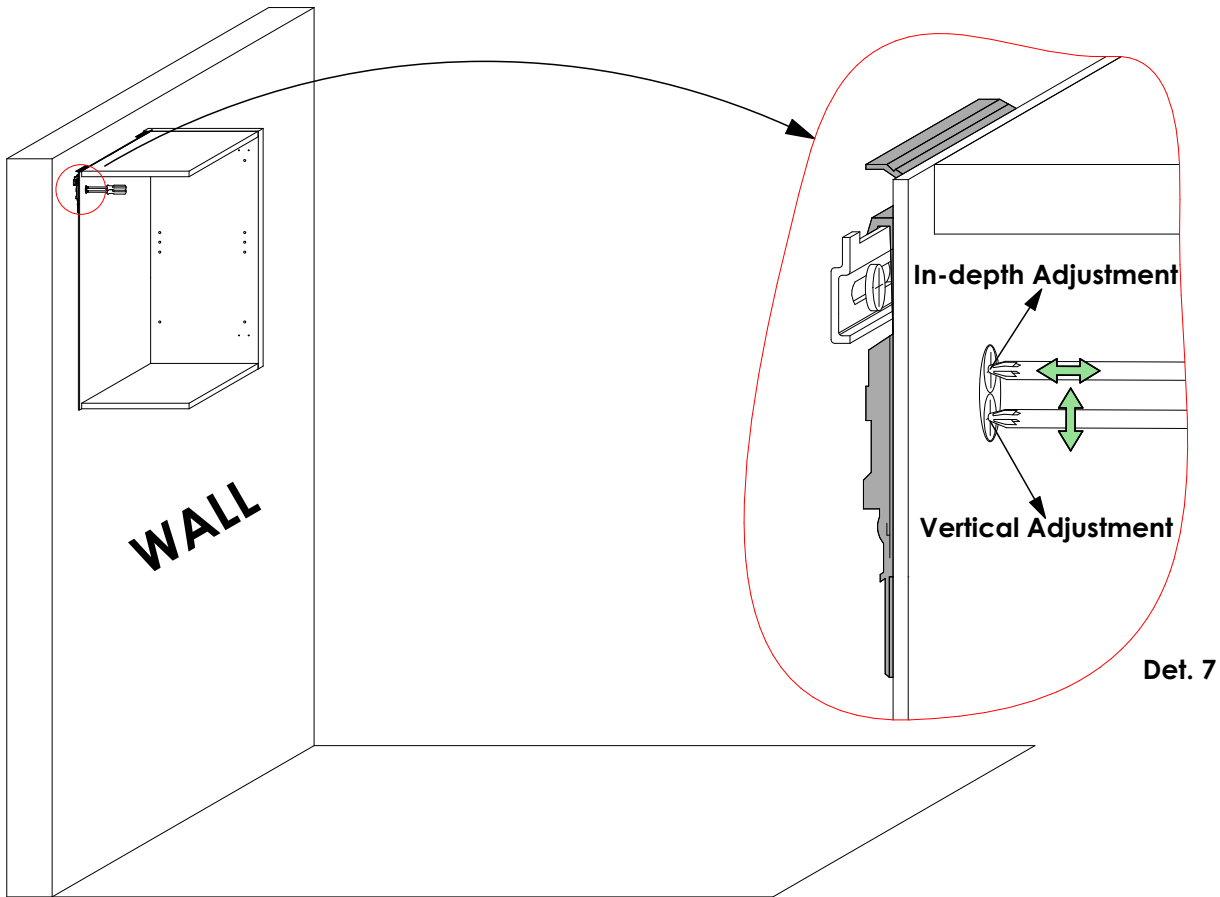

Hang the wall cabinet on the wall by hooking the **APC 1 Hangers** onto the **APC 1 wall plates**. See **Det. 7**. Also see **Det. 7** for **adjustment** details.

## STEP 8

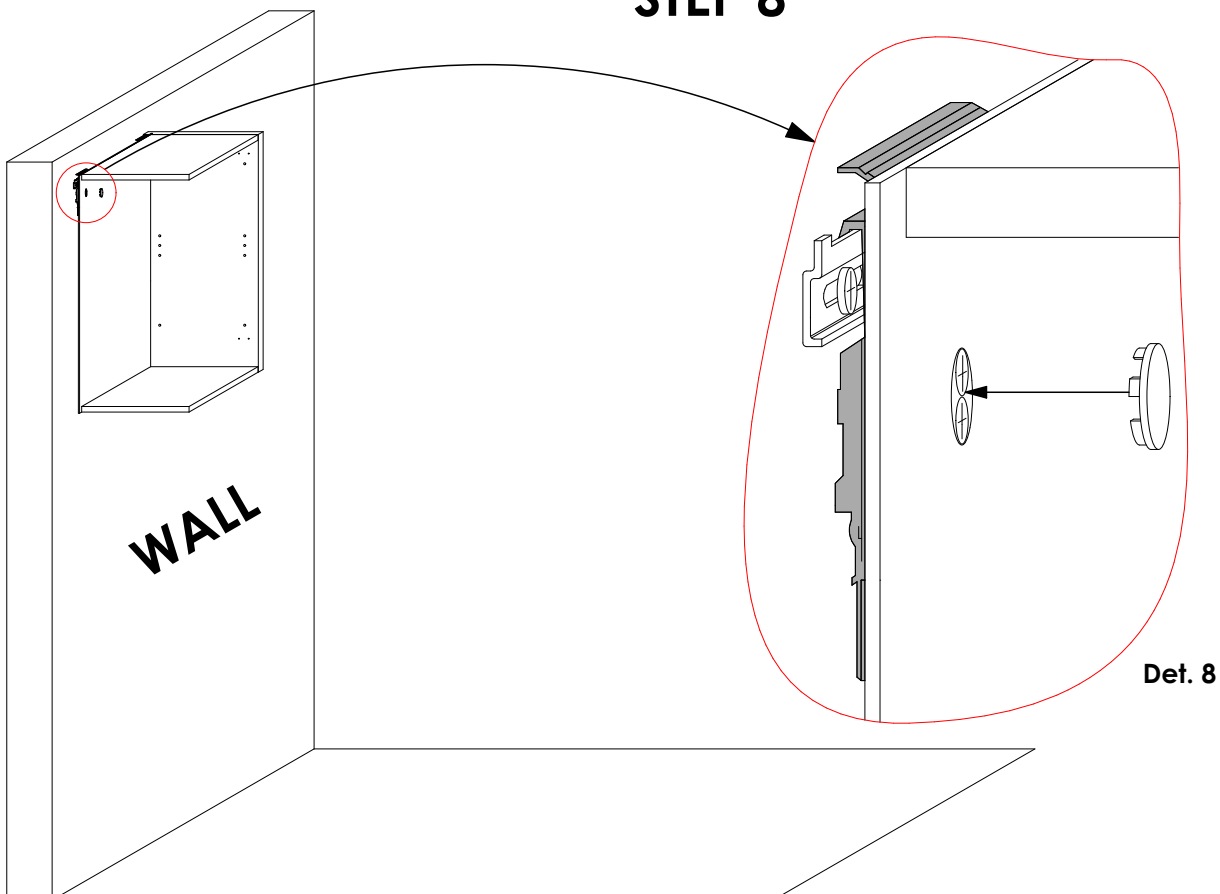

After mounting and levelling the cabinet, snap in the **APC 1 cover caps** to conceal the holes on panel **F**. See **Det. 8**. See the Door Installation Guide for further instructions.