

BLUM FLATPAX KITCHEN RANGE

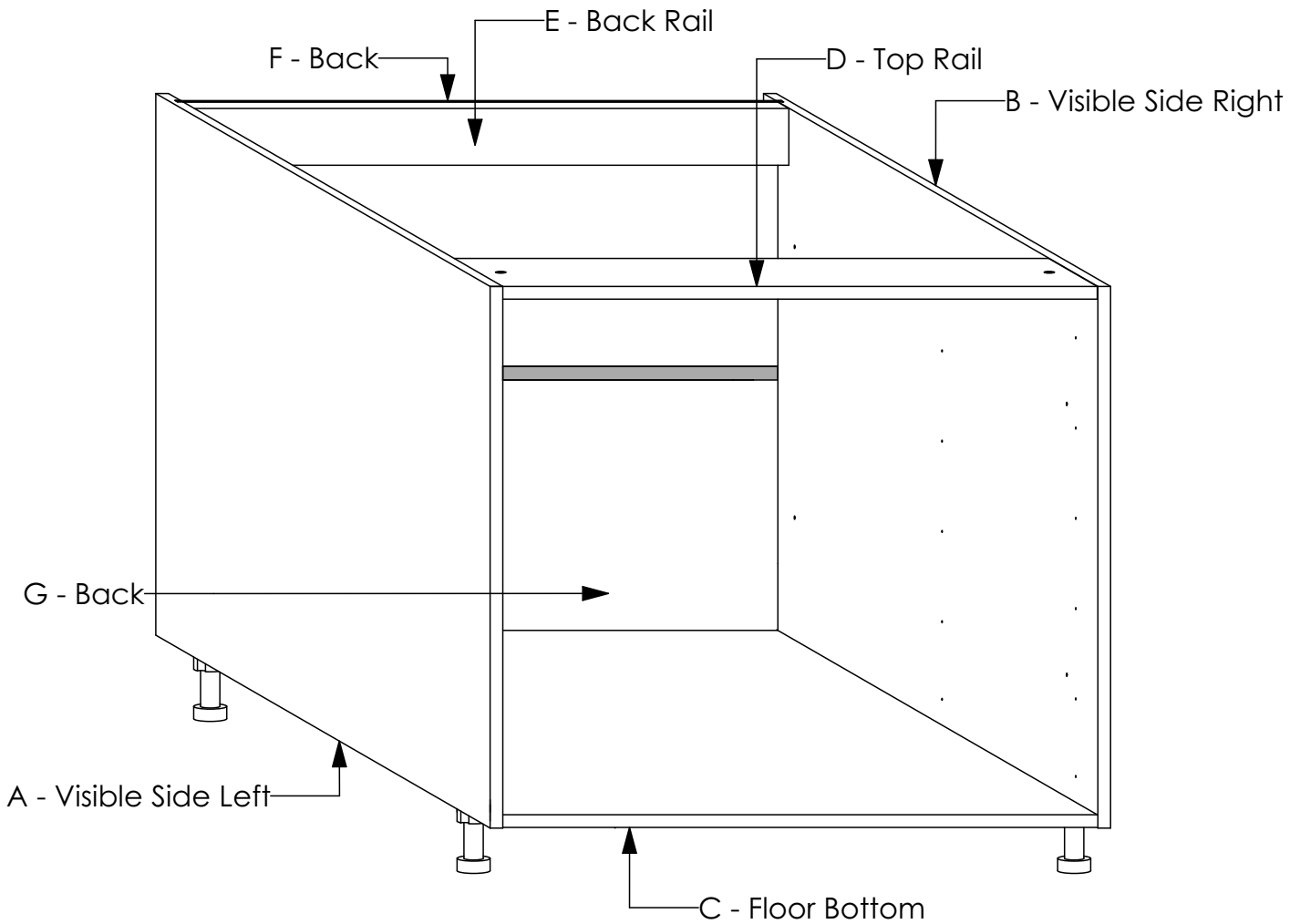





ASSEMBLY GUIDE

BASE CABINET DRAW 900mm



TOTAL NUMBER OF PANELS: 8

HARDWARE

PRODUCT	QTY	IMAGE
Dufix	8	
Minifix	8	
Wooden Dowel	16	
Screw 3.5 x 16mm	22	
Plinth Leg With Base H100mm Kit	4	
Cabinet Connecting Screw Kit	4	
H Profile Backer Connector	1	

TOOLS REQUIRED



Screw Driver
(Pozi Drive Head)

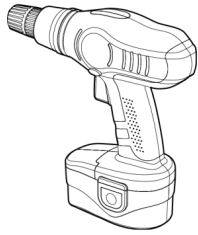

Cordless Drill

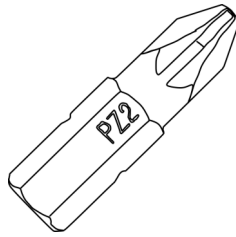

Pozi Bit (PZ2)



8mm Drill Bit



Rubber Mallet

GENERAL INSTRUCTIONS

1. Confirm that all panels (7) are in the package before assembling.
2. Check the white sticker on each panel for the labelling (A, B, C, D, E, F & G).
3. Ensure that the panels are laid on a non-abrasive surface when assembling.
4. Note that all panel connections are done using the system described below.

PANEL CONNECTION AND FASTENING

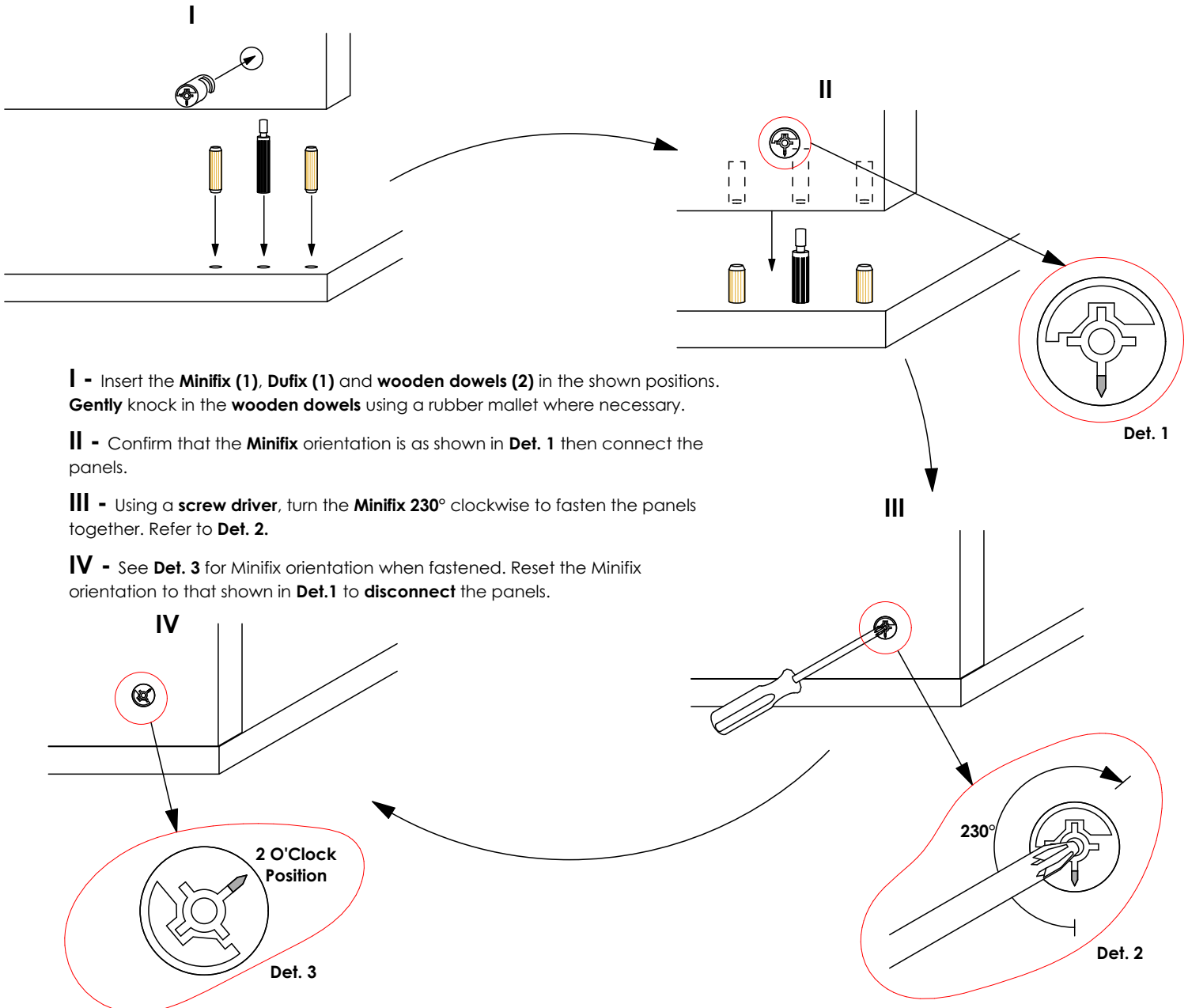

PILOT HOLES KEY FOR SIDE PANELS

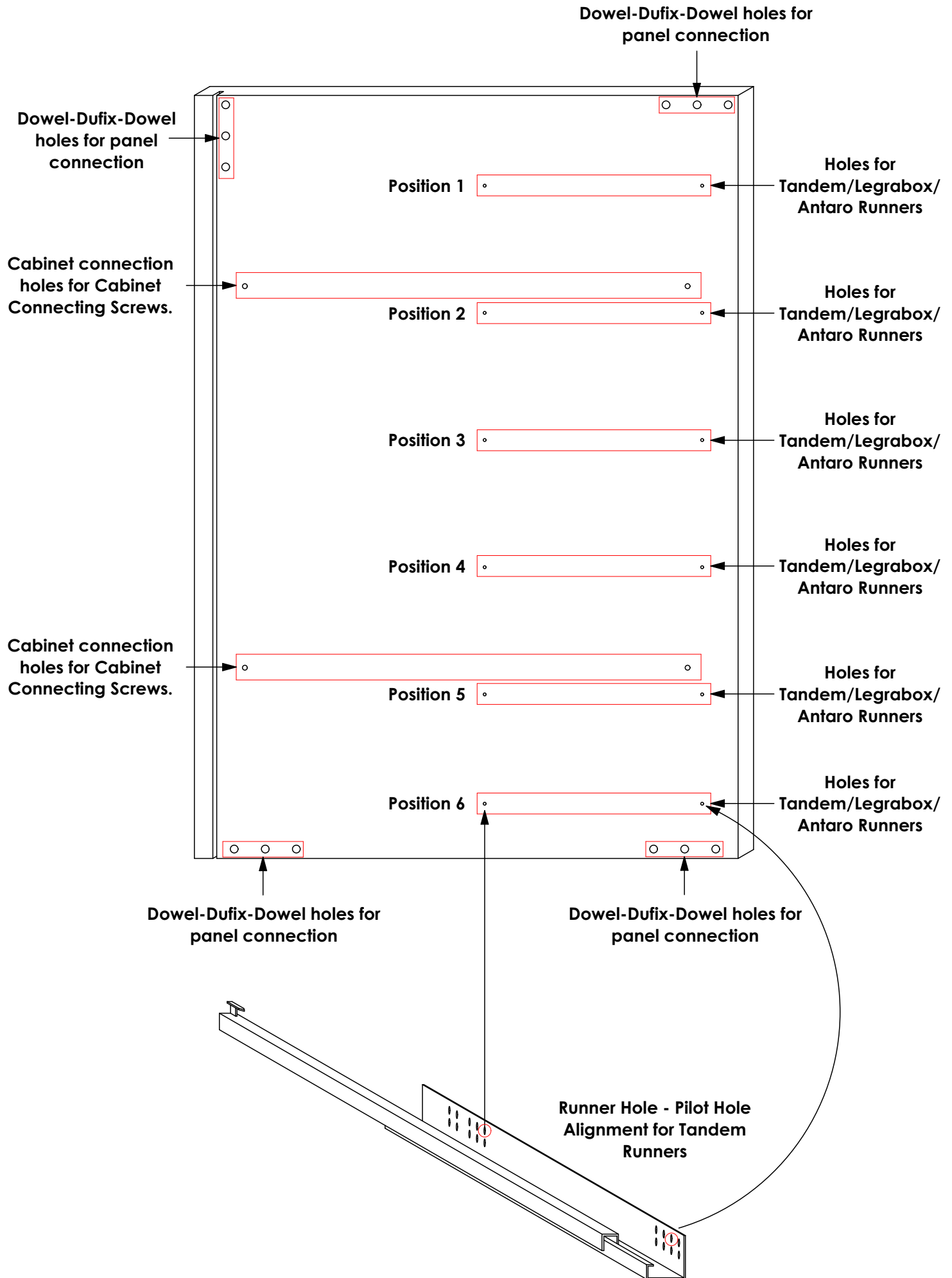

STEP 1

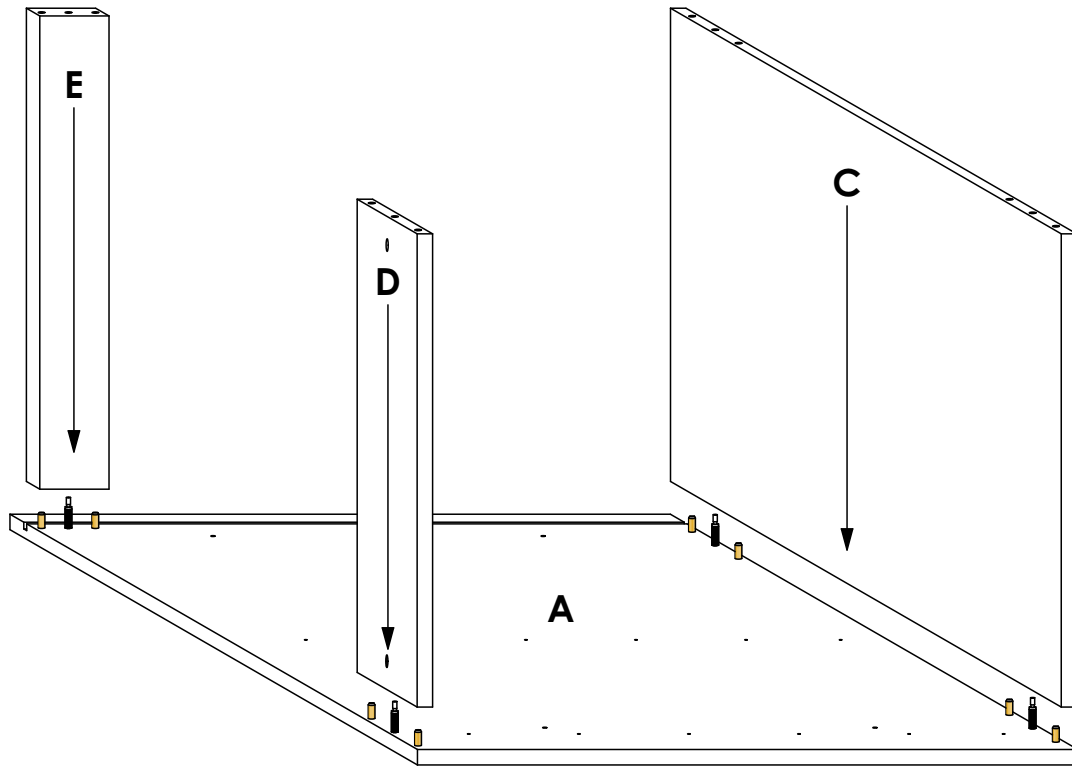

Connect panels **C, D & E** to panel **A** as shown. Refer to the holes and/or grooves on the diagram to determine the panel orientation.

STEP 2

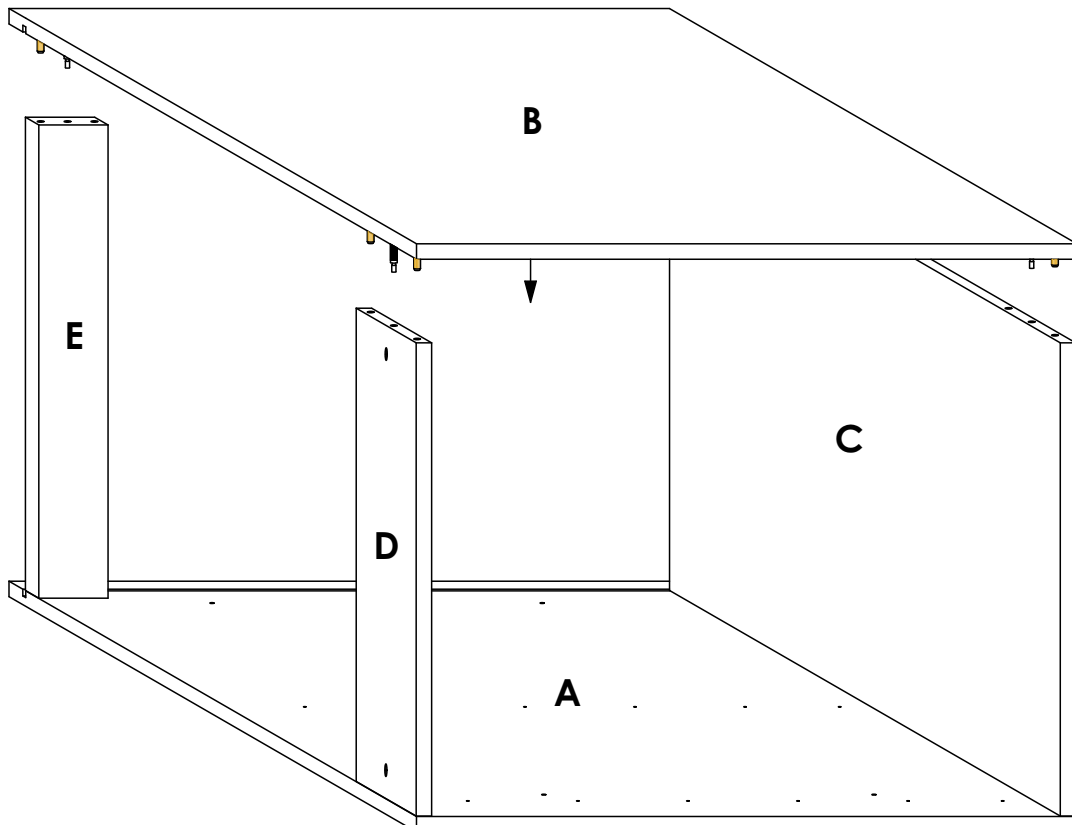

Connect panel **B** to panels **C, D & E** as shown. Refer to the holes and/or grooves on the diagram to determine the panel orientation.

STEP 3

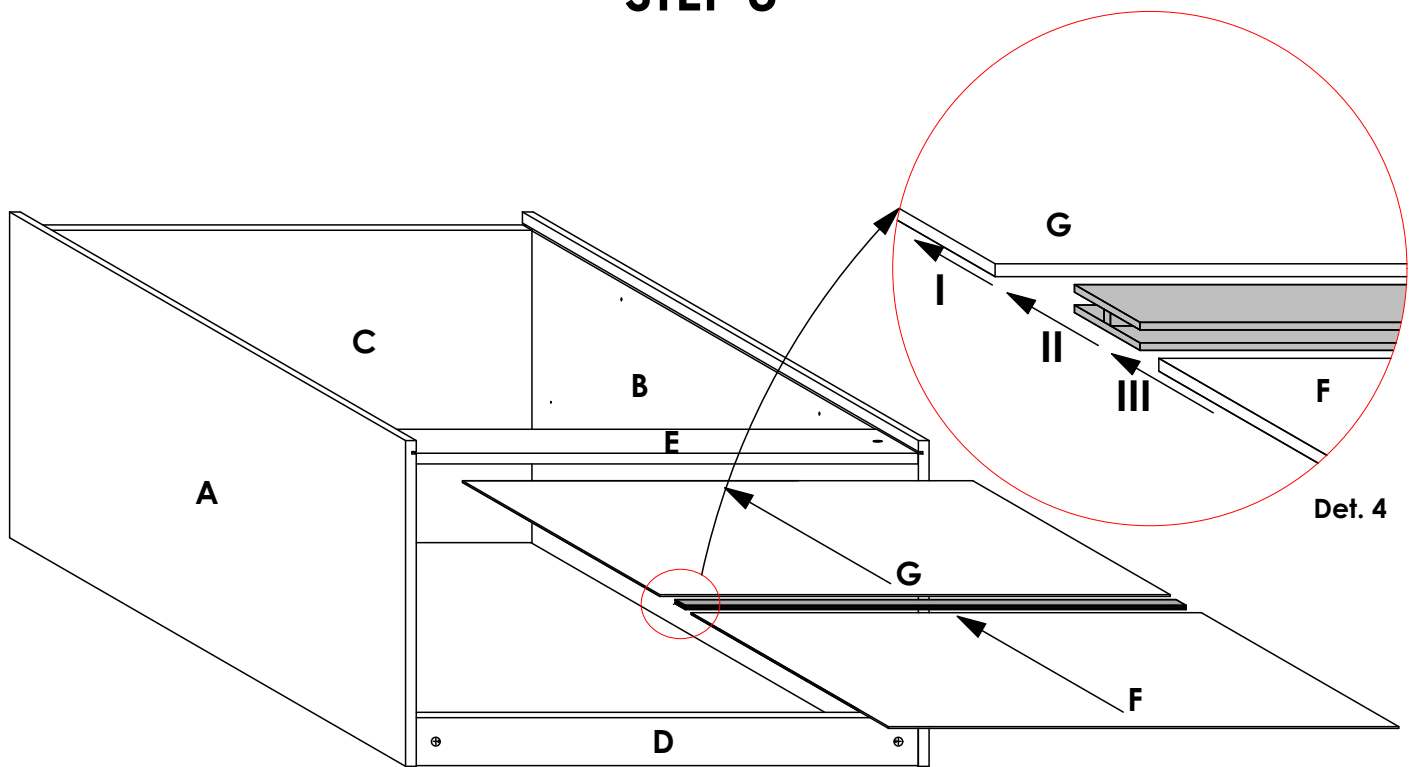

Slide 3mm panel **G** into the groove on panels **A & B** with the finished side facing inside the cabinet. After, insert the **H Profile Backer Connector** into panel **G** as shown (See **Det. 4**). To finish this step, slide 3mm panel **F** through the groove on panels **A & B** and into the **H Profile Backer Connector** as shown in **Det. 4**.

STEP 4

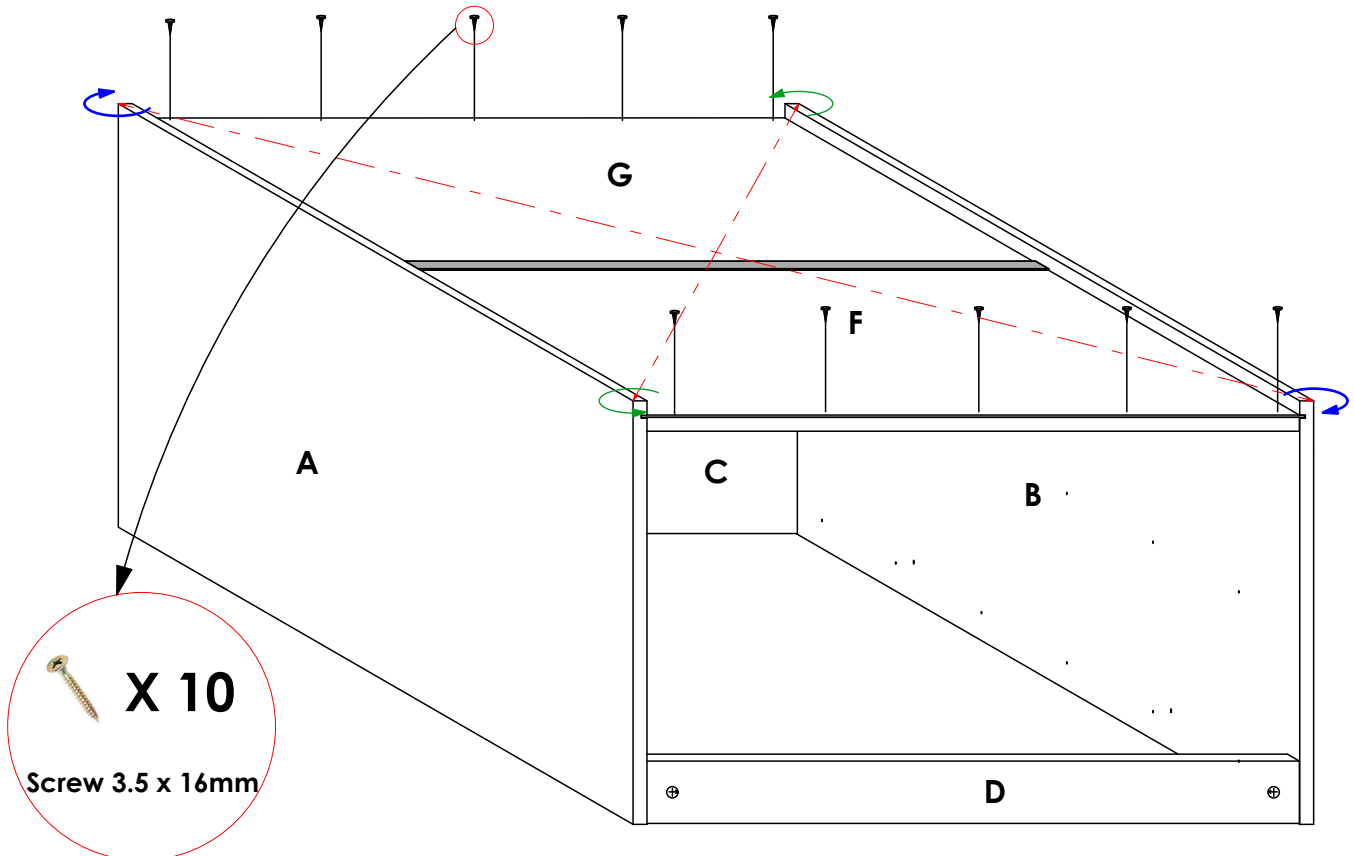

First, **check the diagonal** of the cabinet by measuring the two distances indicated by the broken lines. They should be equal. If not, twist the cabinet accordingly in the diagonal corners as shown until an equal value is achieved. After, secure panels **F & G** to panels **E & C** respectively as shown using **Screw 3.5 X 16mm**.

STEP 5

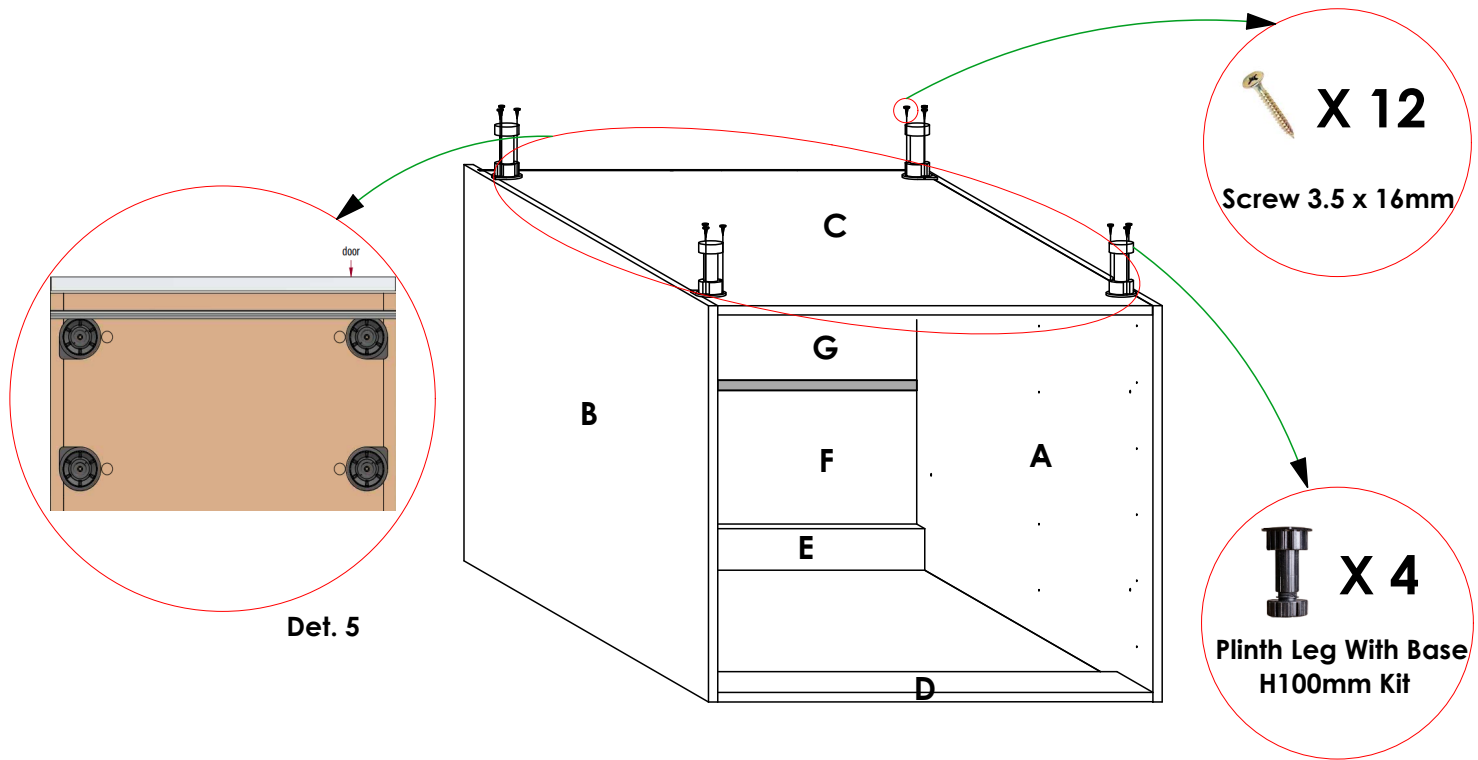

Flip the cabinet up-side down as shown. Place the four units of **Leg Adjustable Base 100mm** in the shown positions, aligning with the pre-drilled pilot holes on panel **C**. Ensure that the orientation is as shown in **Det. 5**. Using **Screw 3.5 X 16mm**, secure the legs onto panel **C**.

STEP 6

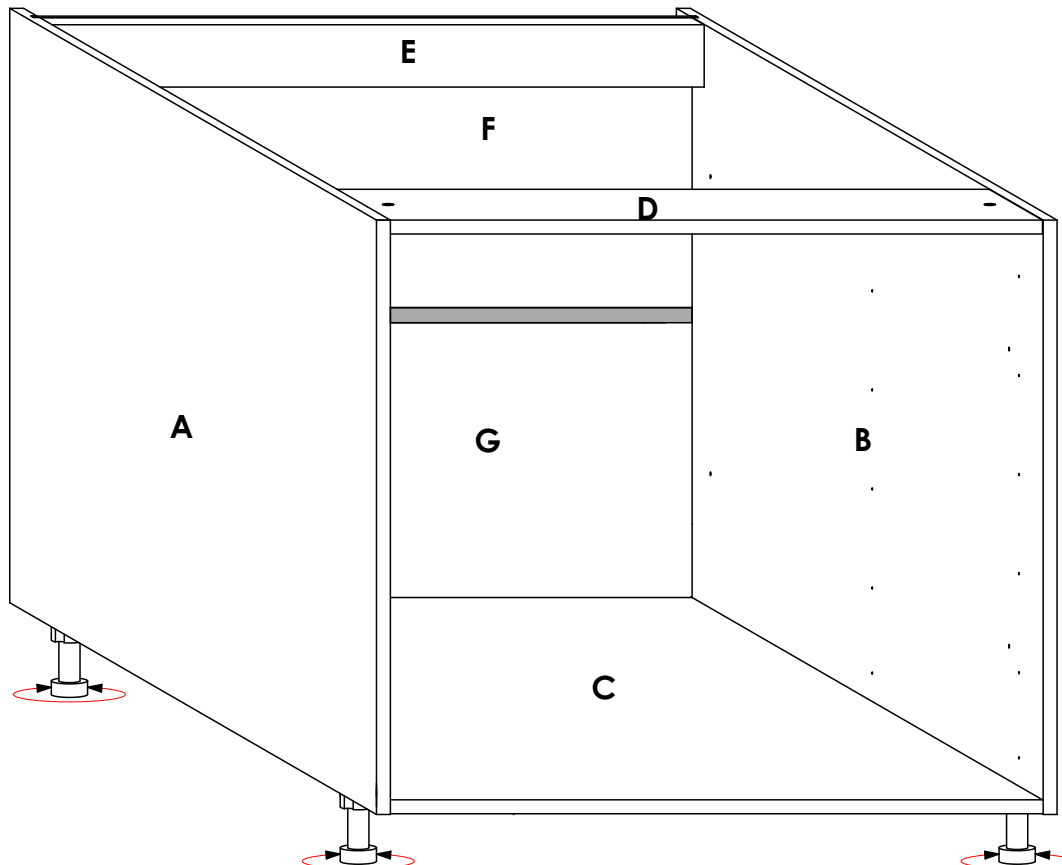

Flip the cabinet upright, place it in the desired position and adjust its height by rotating the base of the legs as shown to level. See the Drawer boxes' installation guides for further instructions.