

# BLUM FLATPAX KITCHEN RANGE

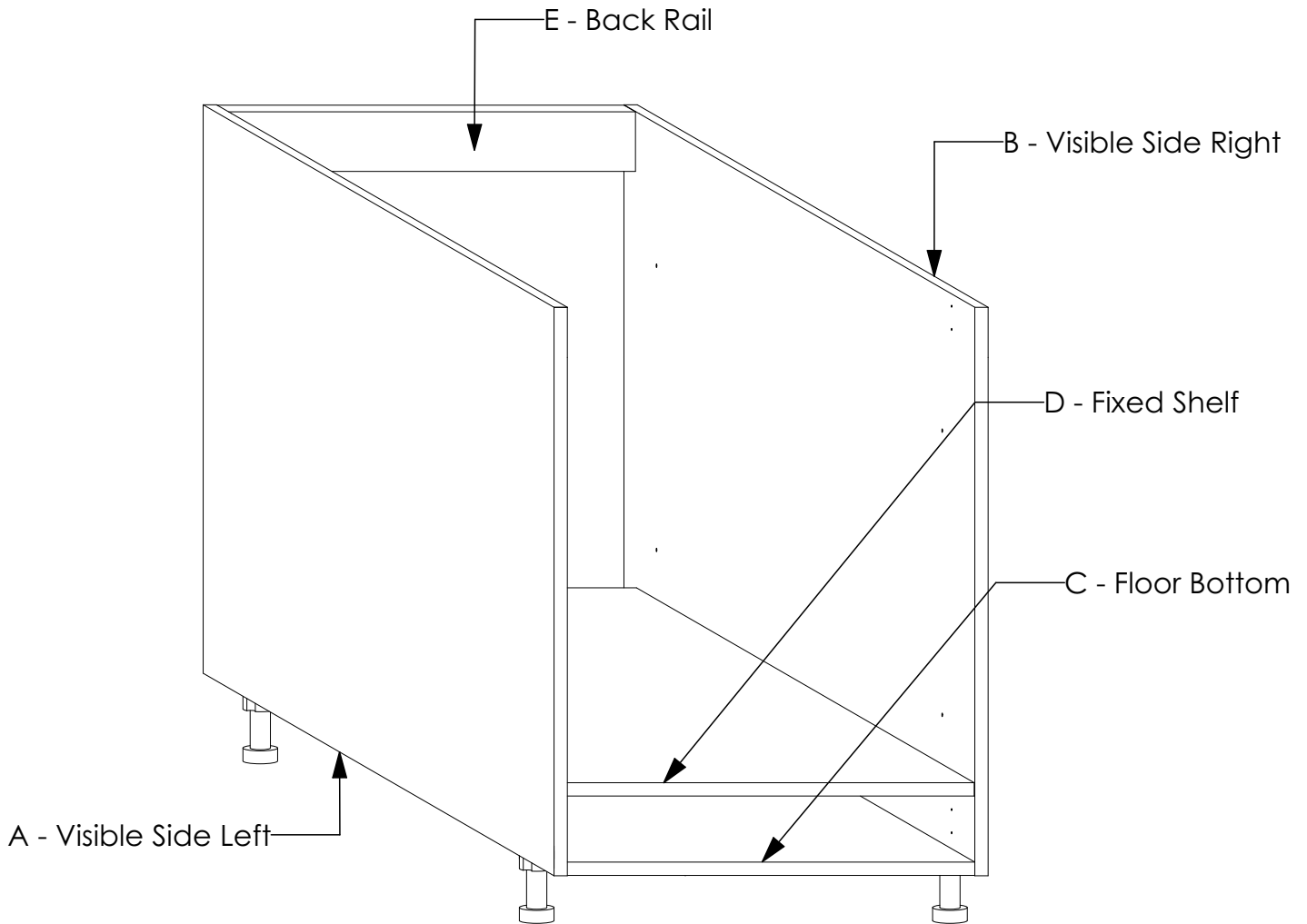





## ASSEMBLY GUIDE

### BASE CABINET OVEN 600mm



**TOTAL NUMBER OF PANELS: 5**

#### HARDWARE

PRODUCT	QTY	IMAGE
Dufix	10	
Minifix	10	
Wooden Dowel	20	
Screw 3.5 x 16mm	12	
Plinth Leg With Base H100mm Kit	4	
Cabinet Connecting Screw Kit	4	

## TOOLS REQUIRED



Screw Driver  
(Pozi Drive Head)

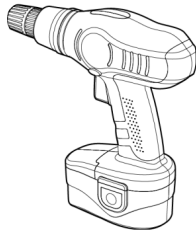

Cordless Drill

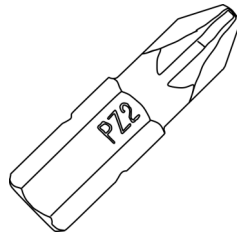

Pozi Bit (PZ2)



8mm Drill Bit



Rubber Mallet

## GENERAL INSTRUCTIONS

1. Confirm that all panels (5) are in the package before assembling.
2. Check the white sticker on each panel for the labelling (A, B, C, D & E).
3. Ensure that the panels are laid on a non-abrasive surface when assembling.
4. Note that all panel connections are done using the system described below.

## PANEL CONNECTION AND FASTENING

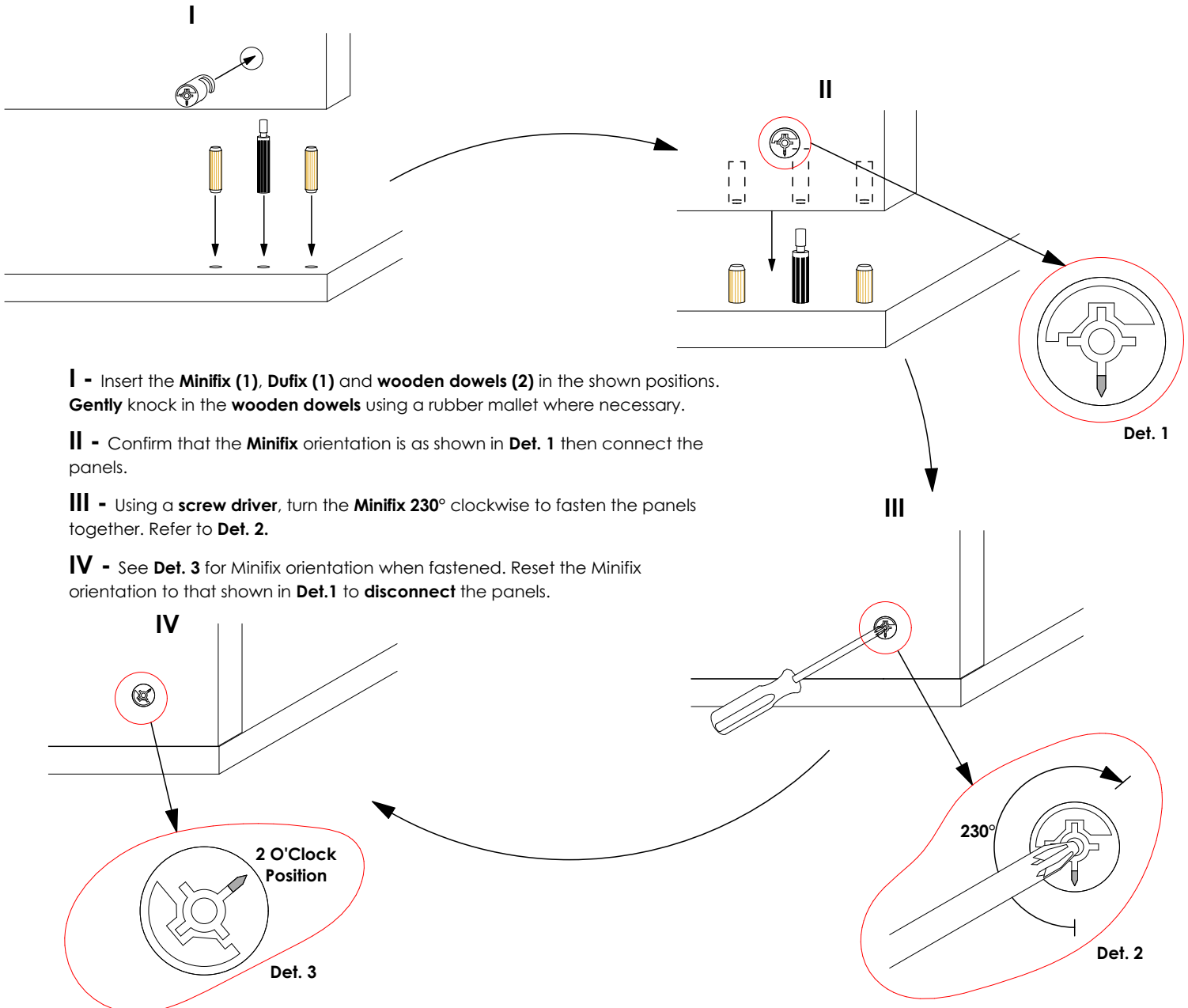

# PILOT HOLES KEY FOR SIDE PANELS

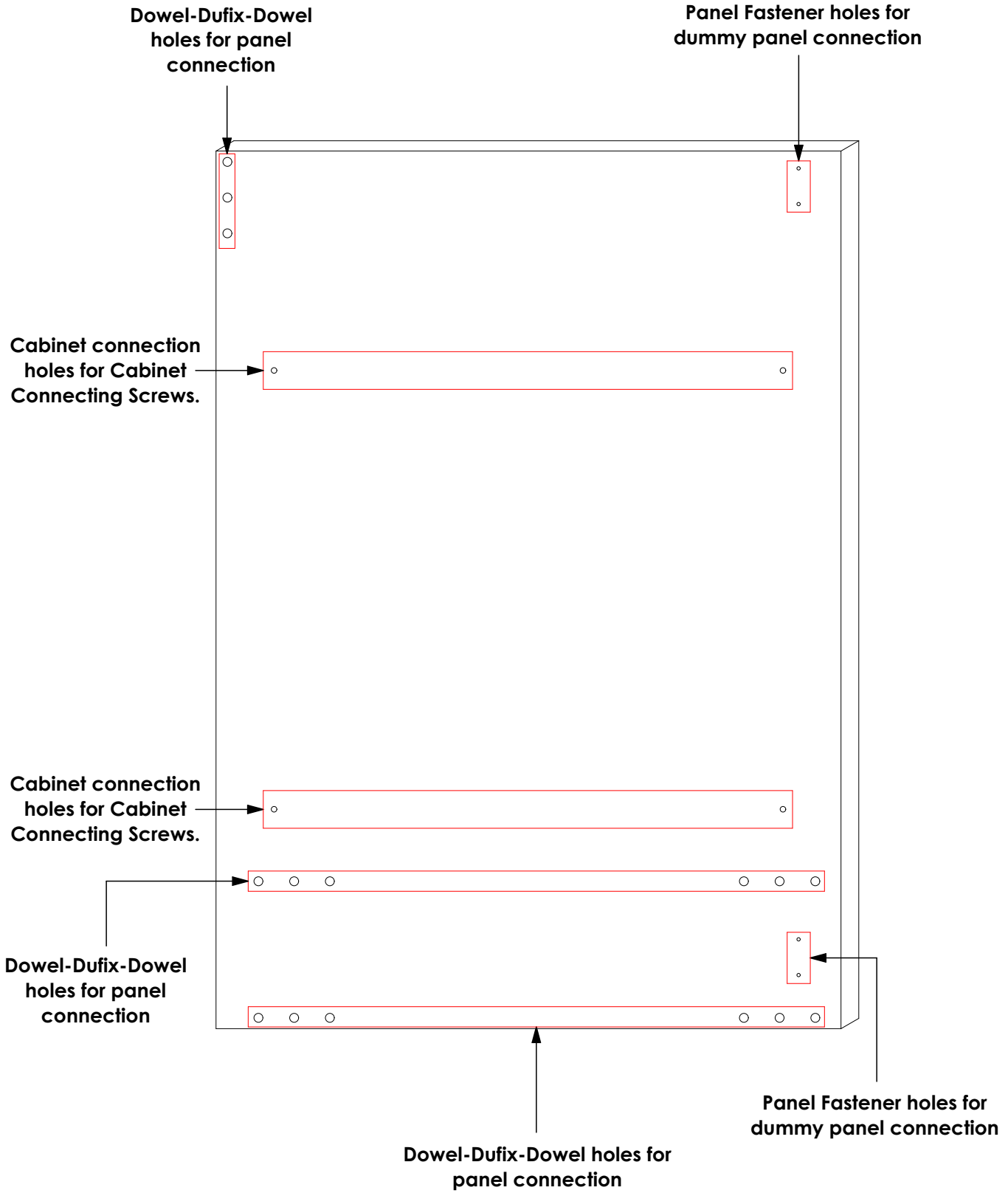

## STEP 1

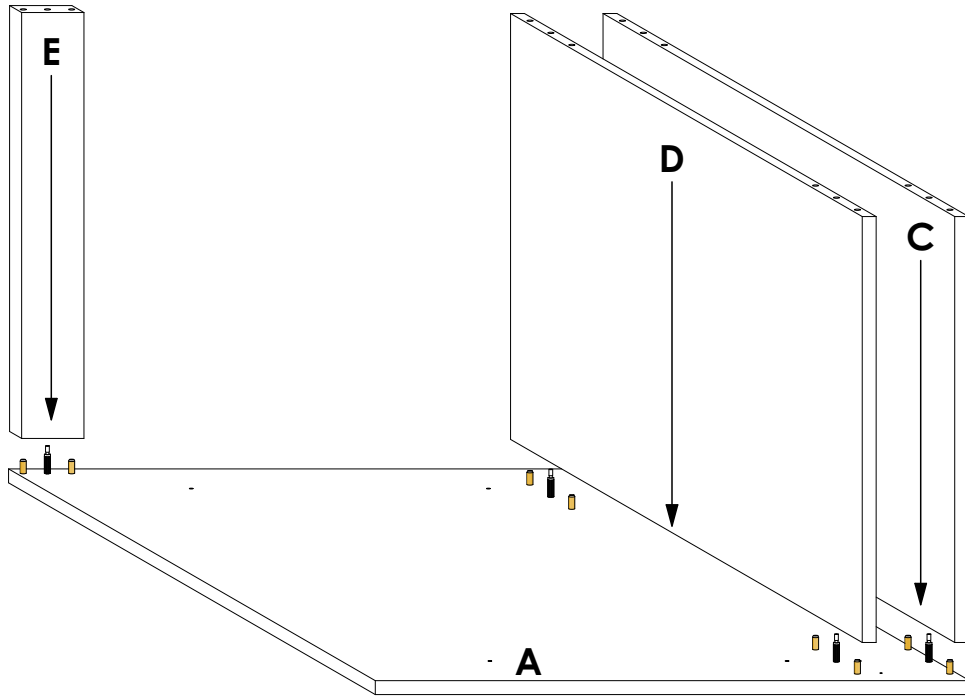

Connect panels **C, D & E** to panel **A** as shown. Refer to the holes and/or grooves on the diagram to determine the panel orientation.

## STEP 2

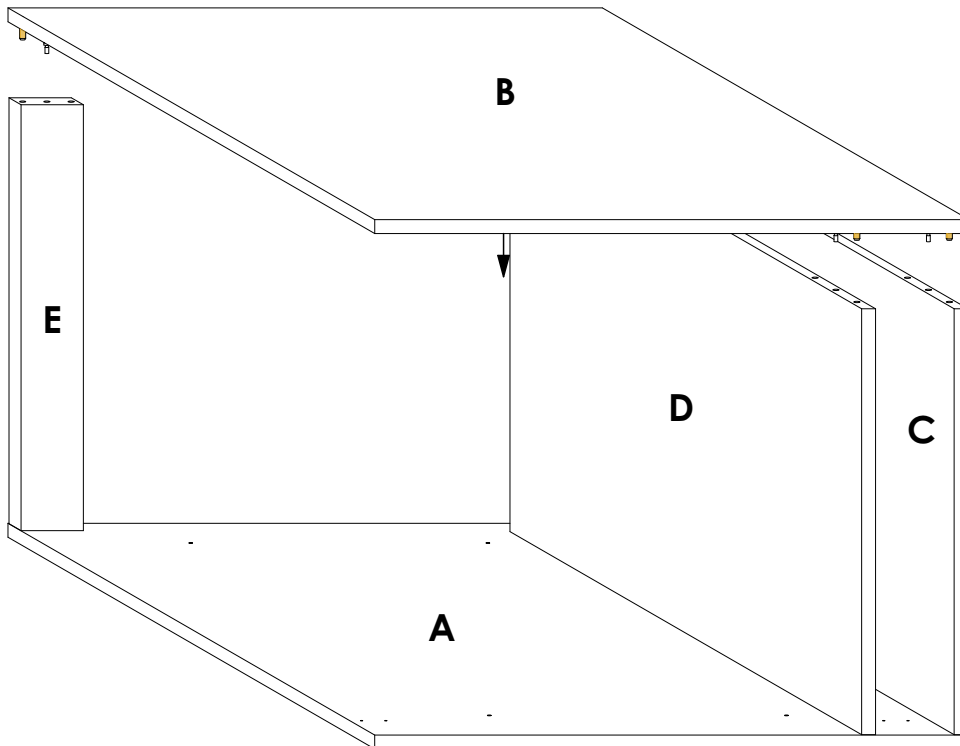

Connect panel **B** to panels **C, D & E** as shown. Refer to the holes and/or grooves on the diagram to determine the panel orientation.

### STEP 3

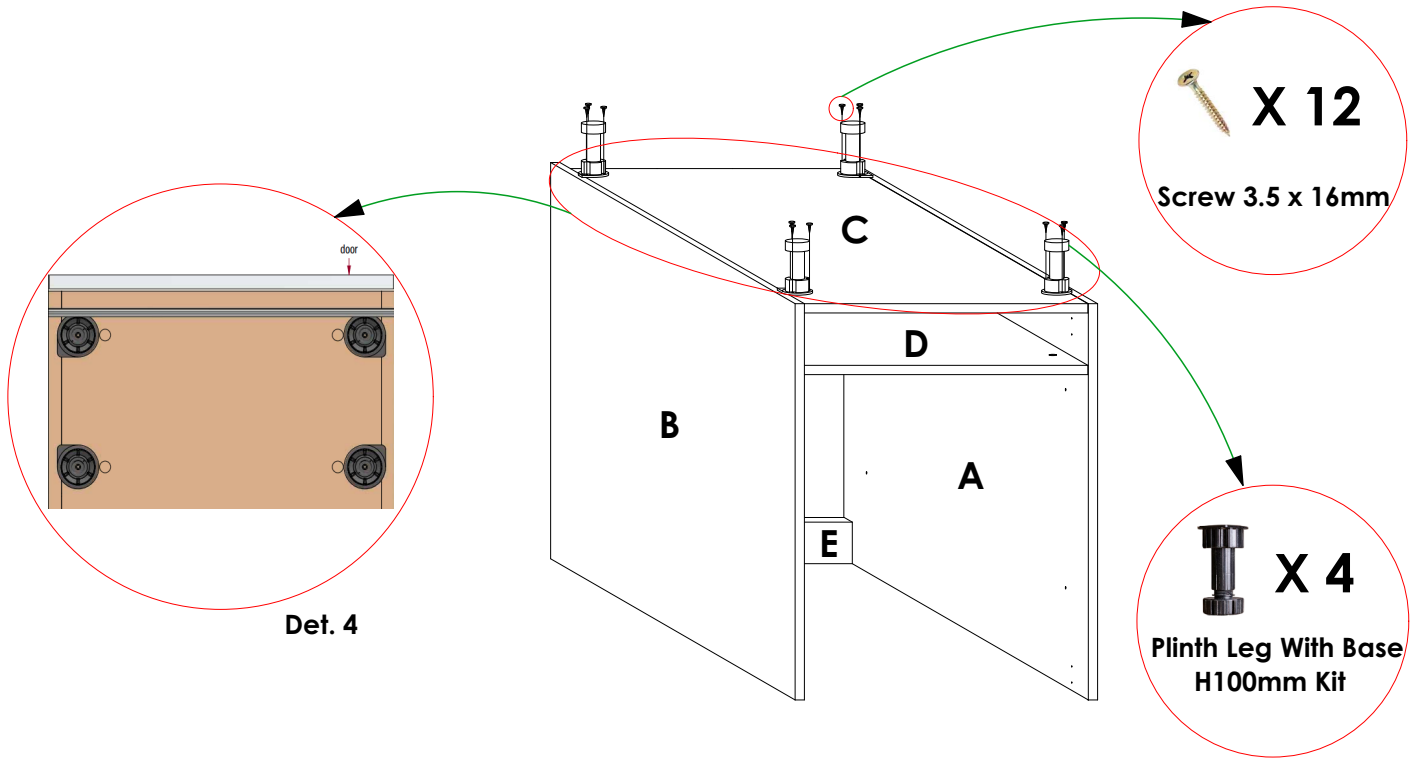

Flip the cabinet up-side down as shown. Place the four units of **Leg Adjustable Base 100mm** in the shown positions, aligning with the pre-drilled pilot holes on panel **C**. Ensure that the orientation is as shown in **Def. 4**. Using **Screw 3.5 X 16mm**, secure the legs onto panel **C**.

### STEP 4

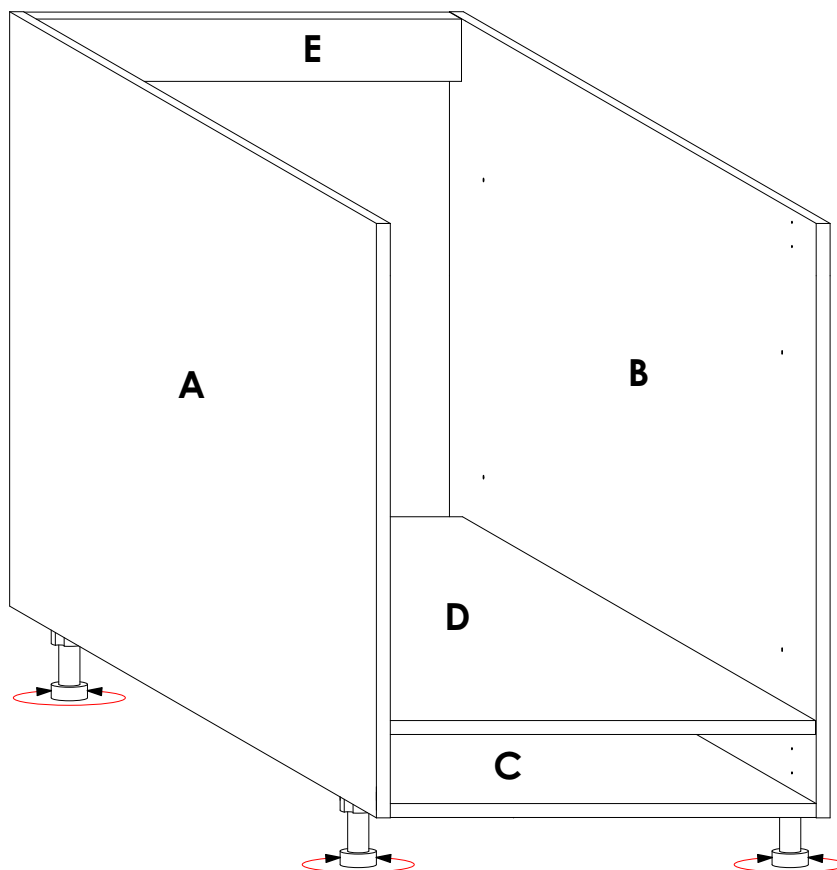

Flip the cabinet upright, place it in the desired position and adjust its height by rotating the base of the legs as shown to level. See the Door and Dummy Panel Installation guide for further instructions.